

EDILBL  C

CATALOGO

Manufatti in cemento 2021

 @edilbloc  @edilblocsnc  @edilbloc

www.edilbloc.eu

TABELLA TRASPORTI

PROVINCIA	CORRIERE	INFERIORE	MOTRICE	BILICO / AUTOTRENO
	PREZZO PALLET	DA 6 A 8 TON	15 TON	30 TON

CUNEO	PER ORDINI INFERIORI A 500 KG UNATANTUM € 45 - PER ORDINI SUPERIORI A 500 KG ADDEBITO DI € 0,10 AL KG	110 €	165 €	230 €
ASTI		125 €	200 €	300 €
TORINO		125 €	200 €	300 €
ALESSANDRIA		140 €	220 €	380 €
BIELLA		140 €	220 €	380 €
NOVARA		140 €	220 €	380 €
VERCELLI		140 €	220 €	380 €
VERBANIA		175 €	300 €	400 €
LA SPEZIA		-	380 €	600 €
GENOVA		140 €	220 €	380 €
IMPERIA		140 €	220 €	380 €
SAVONA		140 €	220 €	380 €
VALLE D'AOSTA		175 €	300 €	400 €

ADDEBITO PER SERVIZIO SUPPLEMENTARE

FERMO MACCHINA DOPO 60 MINUTI - € / ORA	70 €
TRASBORDO DA RIMORCHIO A MOTRICE	70 €
SCARICO GRU INFERIORE	50 €
SCARICO GRU MOTRICE	70 €
SCARICO GRU AUTOTRENO	140 €

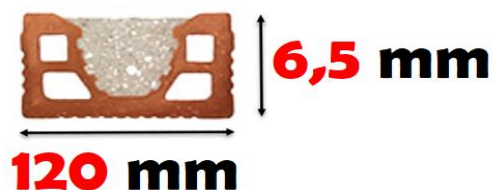

CODICE	PRODOTTO	DIMENSIONI B*H*L	PESO CAD.	PESO PALLET	PEZZI PALLET
--------	----------	---------------------	--------------	----------------	-----------------

LISTINO € / PEZZO

ARCHI100	ARCHITRAVE PRECOMPRESSO LATERIZIO	12 H 6.5 L 100	13,5	608	45	€ 4,90	PL
ARCHI125	ARCHITRAVE PRECOMPRESSO LATERIZIO	12 H 6.5 L 125	16,9	759	45	€ 6,13	PL
ARCHI150	ARCHITRAVE PRECOMPRESSO LATERIZIO	12 H 6.5 L 150	20,3	911	45	€ 7,35	PL
ARCHI175	ARCHITRAVE PRECOMPRESSO LATERIZIO	12 H 6.5 L 175	23,6	1063	45	€ 8,58	PL
ARCHI200	ARCHITRAVE PRECOMPRESSO LATERIZIO	12 H 6.5 L 200	27,0	1215	45	€ 9,80	PL
ARCHI225	ARCHITRAVE PRECOMPRESSO LATERIZIO	12 H 6.5 L 225	30,4	1367	45	€ 11,03	PL
ARCHI250	ARCHITRAVE PRECOMPRESSO LATERIZIO	12 H 6.5 L 250	33,8	1519	45	€ 12,25	PL
ARCHI275	ARCHITRAVE PRECOMPRESSO LATERIZIO	12 H 6.5 L 275	37,1	1671	45	€ 13,48	PL
ARCHI300	ARCHITRAVE PRECOMPRESSO LATERIZIO	12 H 6.5 L 300	40,5	1823	45	€ 14,70	PL
ARCHI325	ARCHITRAVE PRECOMPRESSO LATERIZIO	12 H 6.5 L 325	43,9	1580	36	€ 15,93	SF
ARCHI350	ARCHITRAVE PRECOMPRESSO LATERIZIO	12 H 6.5 L 350	47,3	1701	36	€ 17,15	SF



CODICE	PRODOTTO	DIMENSIONI B*L*H	PESO CAD.	PESO PALLET	PEZZI PALLET	RESISTENZA AL FUOCO	LISTINO € / PEZZO	
CBL2040	BLOCCO CEMENTO	20-40 H 20	14,5	725	50	-	€ 1,50	PL
CBL850	BLOCCO CEMENTO	8-50 H 20	12,5	1495	120	EI 60	€ 1,12	PL
CBL1050	BLOCCO CEMENTO	10-50 H 20	11,7	1055	90	EI 30 TAB	€ 1,37	PL
CBL1250	BLOCCO CEMENTO	12-50 H 20	13,8	1100	80	EI 90	€ 1,37	PL
CBL1250EI120	BLOCCO CEMENTO	12-50 H 20	17,3	1380	80	EI 120	€ 1,90	PL
CBL1550	BLOCCO CEMENTO	15-50 H 20	16,2	1165	72	EI 90	€ 1,50	PL
CBL2050	BLOCCO CEMENTO	20-50 H 20	17,2	1030	60	EI 90	€ 1,77	PL
CBL2050EI120	BLOCCO CEMENTO	20-50 H 20	19,7	1180	60	EI 120	€ 2,30	PL
CBL2550EI120	BLOCCO CEMENTO	25-50 H 20	24,6	1180	48	EI 120	€ 2,70	PL
CBL3050	BLOCCO CEMENTO	30-50 H 20	31,9	1150	36	EI 240 TAB	€ 4,32	PL
CORR2050	CORREA CEMENTO	20-50 H 20	28,5	1425	50	-	€ 4,00	SF
CORR2550	CORREA CEMENTO	25-50 H 20	31,3	1250	40	-	€ 4,70	SF

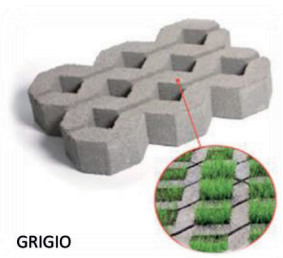
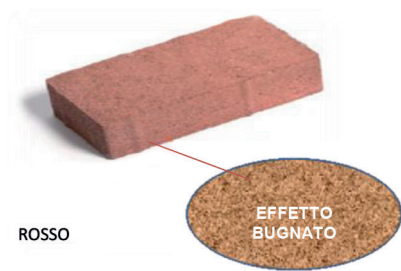
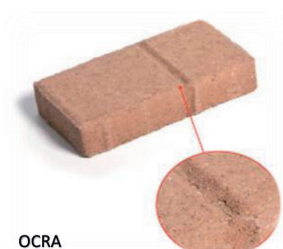
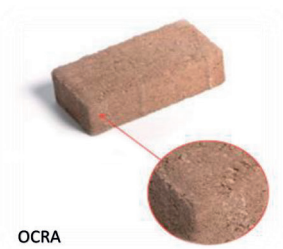

MATTONCINO 20-10 H 6 CM

MQ / PALLET	10	LISTINO € / MQ
KG PALLET	1335	
PEZZI PER MQ	50	
MATT1	MONOSTRATO GRIGIO	€ 17,00
MATT2	MONOSTRATO COLORATO	€ 19,00

PL

MATTONE 12,5-25 H 6 CM

MQ / PALLET	10	LISTINO € / MQ
KG PALLET	1335	
PEZZI PER MQ	32	
MATT3	MONOSTRATO GRIGIO	€ 19,00
MATT4	MONOSTRATO COLORATO	€ 21,00

PL

MATTONE BIS 12,5-25 H 6 CM

MQ / PALLET	10	LISTINO € / MQ
KG PALLET	1335	
PEZZI PER MQ	32	
MATT5	MONOSTRATO GRIGIO	€ 19,00
MATT6	MONOSTRATO COLORATO	€ 21,00

PL

ANTIQUA 12,5-25 H 6 CM

MQ / PALLET	10	LISTINO € / MQ
KG PALLET	1335	
PEZZI PER MQ	32	
ANTIQUA	MONOSTRATO GRIGIO	€ 19,00
ANTIQUA1	MONOSTRATO COLORATO	€ 21,00

PL

TRE PEZZI 8,8-16,4 16,4-16,4 25,2-16,4 H 6 CM

MQ / PALLET	10	LISTINO € / MQ
KG PALLET	1335	
SPESSORE CM	6	
TRIO	MONOSTRATO GRIGIO	€ 20,30
TRIO1	MONOSTRATO COLORATO	€ 22,30

PL

ERBOSO 33,3-50 H 9 CM

MQ / PALLET	8	LISTINO € / MQ
KG PALLET	1140	
PEZZI PALLET	48	
ERBOSO	MONOSTRATO GRIGIO	€ 19,60
ERBOSO1	MONOSTRATO COLORATO	€ 29,70

PL

*** LEGENDA COLORI DISPONIBILI :**



CODICE	PRODOTTO	DIMENSIONI B*L*H	PESO MQ	PESO PALLET	PEZZI PALLET	MQ/ PALLET	LISTINO € / MQ
--------	----------	---------------------	------------	----------------	-----------------	---------------	-------------------

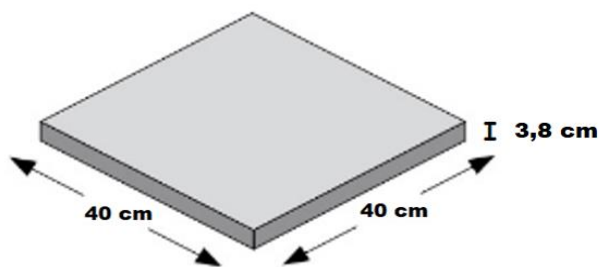

PIASTRA4040GG	PIASTRA GHIAINO LAVATO FINE GRIGIO	40 - 40 H 3,8	85,0	1580	120	19,20	€ 16,00 PL
---------------	--	---------------	------	------	-----	-------	-------------------

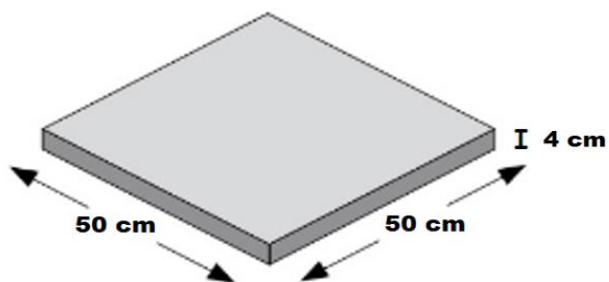

PIASTRA5050GG	PIASTRA GHIAINO LAVATO FINE GRIGIO	50 - 50 H 4	88,9	1200	60	15,00	€ 16,00 PL
---------------	--	-------------	------	------	----	-------	-------------------

**LE PIASTRE SI POSSONO POSARE
ANCHE SU SABBIA O
GALLEGGIANTI REGOLABILI**



CODICE	PRODOTTO	ALTEZZA MM	PESO	PESO SCATOLA	PEZZI PALLET	LISTINO € / CAD.
--------	----------	---------------	------	-----------------	-----------------	---------------------

SS14	SUPPORTO SEMPLICE PEDONALE PER PIASTRELLONI	H 14	0,1	25	300	€ 0,40 SF
------	--	------	-----	----	-----	------------------



**FINO A 2,50 MT IN VERTICALE
FINO A 4,00 MT A SCALARE**

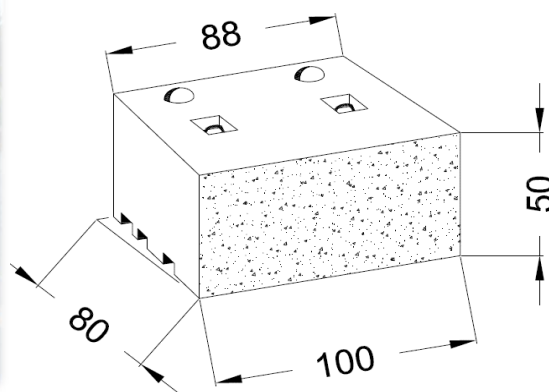

IL BLOCCO E' TRAPEZOIDALE E QUINDI E' POSSIBILE FARE CURVE

CODICE	PRODOTTO	DIMENSIONI B*H*L	PESO CAD.	PESO PALLET	PEZZI PALLET
--------	----------	---------------------	--------------	----------------	-----------------

LISTINO € / PEZZO

MURAJA	MURAJA	100 H 50 - 80	790,0	SFUSO	1
MURAJA2	1/2 BLOCCO	50 H 50 - 80	400,0	SFUSO	1
MURAJA4	1/2 IN ALTEZZA	100 H 25 - 80	400,0	SFUSO	1
MURAJA6	1/2 BLOCCO 1/2 IN ALTEZZA	50 H 25 - 80	200,0	SFUSO	1
MURAJA8	TERMINALE	100 H 50 - 80	500,0	SFUSO	1
MURAJA10	1/2 TERMINALE	50 H 50 - 80	250,0	SFUSO	1

€ 71,00
€ 38,50
€ 62,50
€ 35,00
€ 71,00
€ 38,50

NOTA BENE : SI FA PRESENTE CHE LA REALIZZAZIONE DI MURI DI SOSTEGNO MEDIANTE UTILIZZO DI BLOCCHI CONTRORIVA E' CONSEGUENTE AD UNO STUDIO STRUTTURALE EFFETTUATO DA TECNICI ABILITATI INCARICATI DA COMMITTENTE .
PERTANTO LE INDICAZIONI CONTENUTE NEL DEPLIANT ILLUSTRATIVO A VOSTRE MANI SONO DA INTENDERSI ESCLUSIVAMENTE A TITOLO DI ESEMPI APPLICATIVI.
LE EDILBLOC SNC SI RITIENE QUINDI SOLLEVATA DA QUALSIASI RESPONSABILITA' LEGATA ALL'UTILIZZO DEL MANUFATTO AI FINI DELLA REALIZZAZIONE DELLE OPERE DI SOSTEGNO.

CODICE	PRODOTTO	DIMENSIONI B*L*H	PESO CAD.	PESO PALLET	PEZZI PALLET	COLORE	LISTINO € / PEZZO
--------	----------	---------------------	--------------	----------------	-----------------	--------	----------------------



**N. 12 PEZZI
AL METRO QUADRO**



FIORIERA	FIORIERA	45-36 H 24	28,8	690	24	GRIGIO	€ 9,00	PL
FIORIERACOLOR	FIORIERA COLORATA	45-36 H 24	28,8	690	24	AVANA	€ 11,60	PL



**N. 27 PEZZI AL METRO
SISTEMA CHIUSO**

**N. 19 PEZZI AL METRO
SISTEMA APERTO**



CONTR	CONTRORIVA GRIGIO	31-25 H 18	17,5	1260	72	GRIGIO	€ 3,40	PL
CONTRCOLOR	CONTRORIVA COLORATO	31-25 H 18	17,5	1260	72	ROSSO / AVANA	€ 4,40	PL

***ATTENZIONE
PEZZO INTERO DA
SPLITTARE**



**N. 32 PEZZI SPLITTATI
AL METRO QUADRO**

**2,60 METRI QUADRI
A PALLET**



MURO	CONTRORIVA GRIGIO	51-25 H 12,5	29	1370	42	GRIGIO	€ 6,20	PL
MUROCOLOR	CONTRORIVA COLORATO	51-25 H 12,5	29	1370	42	ROSSO / AVANA	€ 8,30	PL



**N. 24 PEZZI
AL METRO QUADRO**

**2,00 METRI QUADRI
A PALLET**

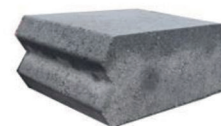

GARDENGR	CONTRORIVA GRIGIO	32-25 H 15	26	1400	54	GRIGIO	€ 4,20	PL
GARDENCO	CONTRORIVA COLORATO	32-25 H 15	26	1400	54	ROSSO / AVANA	€ 5,25	PL

NOTA BENE : SI FA PRESENTE CHE LA REALIZZAZIONE DI MURI DI SOSTEGNO MEDIANTE UTILIZZO DI BLOCCHI CONTRORIVA E' CONSEGUENTE AD UNO STUDIO STRUTTURALE EFFETTUATO DA TECNICI ABILITATI INCARICATI DA COMMITTENTE .
PERTANTO LE INDICAZIONI CONTENUTE NEL DEPLIANT ILLUSTRATIVO A VOSTRE MANI SONO DA INTENDERSI ESCLUSIVAMENTE A TITOLO DI ESEMPI APPLICATIVI.
LE EDILBLOC SNC SI RITIENE QUINDI SOLLEVATA DA QUALSIASI RESPONSABILITA' LEGATA ALL'UTILIZZO DEL MANUFATTO AI FINI DELLA REALIZZAZIONE DELLE OPERE DI SOSTEGNO.

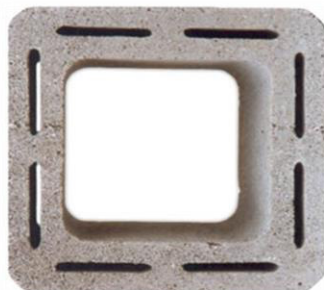

CODICE	PRODOTTO	DIMENSIONI	PESO	PESO	METRI
	DIMENSIONI	ESTERNE			
	INTERNE	B*L*H	MT	PALLET	PALLET

LISTINO € / MT

CANNA1515	CAMICIA 15x15	25-25 H 25	50,0	1000	20
CANNA1520	CAMICIA 15x20	25-30 H 25	46,0	736	16
CANNA1530	CAMICIA 15x30	25-40 H 25	62,0	744	12
CANNA2020	CAMICIA 20x20	30-30 H 25	62,0	992	16
CANNA2030	CAMICIA 20x30	30-40 H 25	72,0	864	12
CANNA2525	CAMICIA 25x25	35-35 H 25	72,0	648	9
CANNA3030	CAMICIA 30x30	40-40 H 25	85,0	765	9
CANNA3040	CAMICIA 30x40	40-50 H 25	95,0	570	6
CANNA4040	CAMICIA 40x40	50-50 H 25	100,0	400	4

€	15,10	PL
€	18,90	PL
€	20,90	PL
€	19,50	PL
€	21,10	PL
€	24,90	PL
€	27,00	PL
€	31,00	PL
€	42,50	PL



CODICE	PRODOTTO	DIMENSIONI ESTERNE B*L*H	PESO		PEZZI PALLET	LISTINO €/COMIGN. COMPLETO
			CAD.	PALLET		
COM1515	COMIGNOLO 15X15	3 ELEM.+ 1 TESTA	39,00	468	12	€ 40,00 SF
	ELEMENTO	33-33 H 12,5	9,75			
	TESTA COMIGNOLO	28-28 H 5,5	9,75			
COM1520	COMIGNOLO 15X20	3 ELEM.+ 1 TESTA	44,00	528	12	€ 40,00 SF
	ELEMENTO	30-35 H 12	11,00			
	TESTA COMIGNOLO	27-32 H 5	11,00			
COM1530	COMIGNOLO 15X30	3 ELEM.+ 1 TESTA	54,00	432	8	€ 40,00 SF
	ELEMENTO	33-48 H 13,5	13,50			
	TESTA COMIGNOLO	27-42 H 5,7	13,50			
COM1540	COMIGNOLO 15X40	3 ELEM.+ 1 TESTA	79,00	948	12	€ 45,00 SF
	ELEMENTO	34-59 H 14	19,75			
	TESTA COMIGNOLO	27-52 H 5,7	19,75			
COM2020	COMIGNOLO 20X20	3 ELEM.+ 1 TESTA	58,00	696	12	€ 40,00 SF
	ELEMENTO	37,5-37,5 H 13	14,50			
	TESTA COMIGNOLO	32-32 H 5	14,50			
COM2025	COMIGNOLO 20X25	3 ELEM.+ 1 TESTA	57,00	456	8	€ 40,00 SF
	ELEMENTO	38-43 H 13	14,25			
	TESTA COMIGNOLO	32-37 H 5,5	14,25			
COM2030	COMIGNOLO 20X30	3 ELEM.+ 1 TESTA	77,00	616	8	€ 43,00 SF
	ELEMENTO	41-51 H 13,7	19,25			
	TESTA COMIGNOLO	32-42 H 5,5	19,25			
COM2040	COMIGNOLO 20X40	3 ELEM.+ 1 TESTA	105,00	840	8	€ 61,00 SF
	ELEMENTO	41,5-61,5 H 14	26,25			
	TESTA COMIGNOLO	32-52 H 14	26,25			
COM2525	COMIGNOLO 25X25	3 ELEM.+ 1 TESTA	75,00	600	8	€ 45,00 SF
	ELEMENTO	43,5-43,5 H 14	18,75			
	TESTA COMIGNOLO	38-38 H 6	18,75			
COM3030	COMIGNOLO 30X30	3 ELEM.+ 1 TESTA	106,00	848	8	€ 72,00 SF
	ELEMENTO	53-53 H 15	26,50			
	TESTA COMIGNOLO	42-42 H 6,7	26,50			
COM3040	COMIGNOLO 30X40	3 ELEM.+ 1 TESTA	175,00	700	4	€ 105,00 SF
	ELEMENTO	56-66 H 17	35,00			
	TESTA COMIGNOLO	43-53 H 7,5	35,00			
COM4040	COMIGNOLO 40X40	3 ELEM.+ 1 TESTA	199,00	796	4	€ 108,00 SF
	ELEMENTO	64-64 H 16	39,80			
	TESTA COMIGNOLO	54-54 H 7	39,80			
COM4050	COMIGNOLO 40X50	3 ELEM.+ 1 TESTA	203,00	812	4	€ 114,00 SF
	ELEMENTO	54-64 H 16	40,60			
	TESTA COMIGNOLO	61-71 H 7	40,60			
COM5050	COMIGNOLO 50X50	3 ELEM.+ 1 TESTA	210,00	840	4	€ 202,00 SF
	ELEMENTO	71-71 H 16	42,00			
	TESTA COMIGNOLO	55-55 H 7	42,00			



CHIUSINO

CODICE	PRODOTTO	DIMENSIONI ESTERNE B*L*H	PESO CAD.	PESO PALLET	PEZZI PALLET
CCH25	CHIUSINO PEDONALE X POZZETTO 25	30-30 H 05	14	420	30
CCH30	CHIUSINO PEDONALE X POZZETTO 30	37-37 H 06	16	384	24
CCH40	CHIUSINO PEDONALE X POZZETTO 40	50-50 H 09	41	492	12
CCH50	CHIUSINO PEDONALE X POZZETTO 50	60-60 H 09	59	708	12
CCH60	CHIUSINO PEDONALE X POZZETTO 60	74-74 H 08	80	400	5
CCH70	CHIUSINO PEDONALE X POZZETTO 70	80-80 H 07	94	470	5
CCH80	CHIUSINO PEDONALE X POZZETTO 80	95-95 H 10	145	725	5
CCH100	CHIUSINO PEDONALE X POZZETTO 100	115-115 H 10	270	1350	5

LISTINO € / PEZZO	
€ 11,00	SF
€ 13,00	SF
€ 17,10	SF
€ 19,30	SF
€ 29,60	SF
€ 53,00	SF
€ 56,50	SF
€ 68,00	SF



TAPPO

CODICE	PRODOTTO	DIMENSIONI ESTERNE B*L*H	PESO CAD.	PESO PALLET	PEZZI PALLET
CTP25	COPERCHIO LEGGERO X POZZETTO DA 25	30-30 H 3	6	180	30
CTP30	COPERCHIO LEGGERO X POZZETTO DA 30	40-40 H 3.5	12	288	24
CTP40	COPERCHIO LEGGERO X POZZETTO DA 40	50-50 H 4	15	180	12
CTP50	COPERCHIO LEGGERO X POZZETTO DA 50	60-60 H 4.5	32	384	12
CTP60	COPERCHIO LEGGERO X POZZETTO DA 60	70-70 H 5	40	400	10

LISTINO € / PEZZO	
€ 5,80	SF
€ 6,10	SF
€ 7,30	SF
€ 10,40	SF
€ 13,80	SF

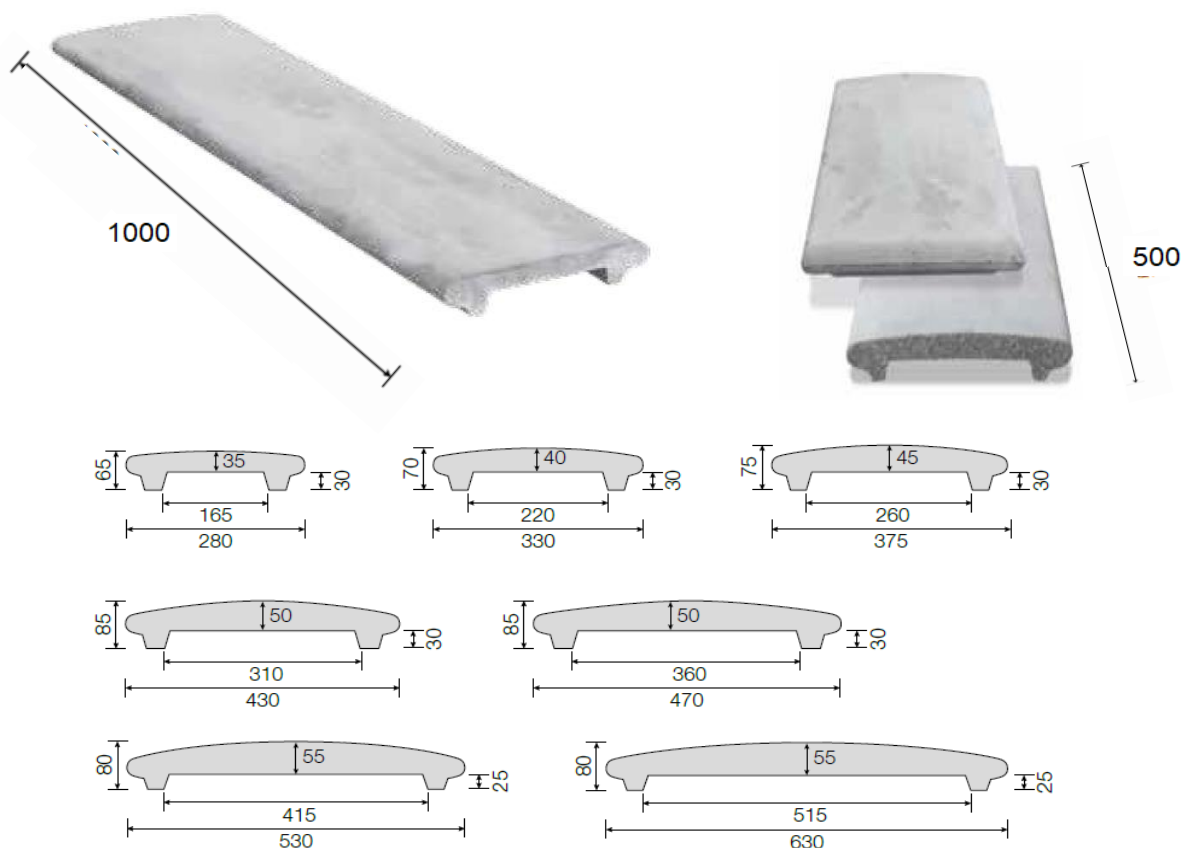

CODICE	PRODOTTO	DIMENSIONI INTERNE B*L*H	PESO CAD.	PESO PALLET	PEZZI PALLET
--------	----------	--------------------------	-----------	-------------	--------------

LISTINO € / PEZZO

COPER15	COPERTINA PER MURO DA 15 CM	16,5-100 H 3,0	23,0	1380	60
COPER20	COPERTINA PER MURO DA 20 CM	22-100 H 3,0	26,0	1170	45
COPER25	COPERTINA PER MURO DA 25 CM	26-100 H 3,0	33,0	1485	45
COPER30	COPERTINA PER MURO DA 30 CM	31-100 H 3,0	43,0	1290	30
COPER35	COPERTINA PER MURO DA 35 CM	36-100 H 3,0	51,0	1530	30
COPER40	COPERTINA PER MURO DA 40 CM	41,5-100 H 2,5	59,0	1180	20
COPER50	COPERTINA PER MURO DA 50 CM	51,5-100 H 2,5	73,0	1460	20

€	11,90	SF
€	13,00	SF
€	15,50	SF
€	20,70	SF
€	24,60	SF
€	29,30	SF
€	39,00	SF

TESTA15	TESTATA PER MURO DA 15 CM	16,5-50 H 3,0	10,5	-	1
TESTA20	TESTATA PER MURO DA 20 CM	22-50 H 3,0	13,5	-	1
TESTA25	TESTATA PER MURO DA 25 CM	26-50 H 3,0	16,3	-	1
TESTA30	TESTATA PER MURO DA 30 CM	31-50 H 3,0	21,3	-	1
TESTA35	TESTATA PER MURO DA 35 CM	36-50 H 3,0	25,5	-	1
TESTA40	TESTATA PER MURO DA 40 CM	41,5-50 H 2,5	32,0	-	1
TESTA50	TESTATA PER MURO DA 50 CM	51,5-50 H 2,5	40,0	-	1

€	29,30
€	34,00
€	39,00
€	44,00
€	46,50
€	48,50
€	58,50



PRIMA



DOPO

**LUNGO 50 CM
10 X 10 CM
VASTA GAMMA DI COLORI**

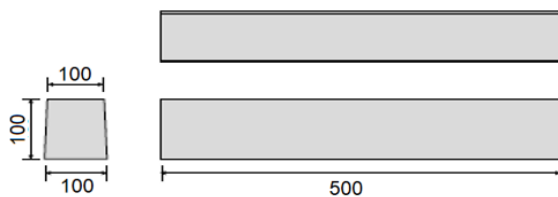

CODICE	PRODOTTO	DIMENSIONI B1*B2*L*H	PESO CAD.	PESO PALLET	PEZZI PALLET
--------	----------	-------------------------	--------------	----------------	-----------------

LISTINO € / PEZZO

BINDERO	BINDERO GRIGIO	10-10-50 H 10	10	960	96
BINDEROCOLOR	BINDERO COLORATO	10-10-50 H 10	10	960	96

€	4,00	SF
€	9,00	SF

CORDOLI IN CEMENTO VIBRATO

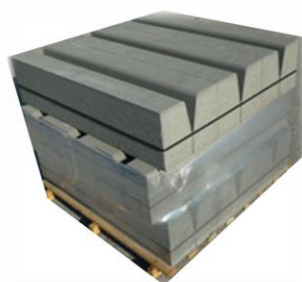

CODICE	PRODOTTO	DIMENSIONI B1*B2*L*H	PESO CAD.	PESO PALLET	PEZZI PALLET
--------	----------	-------------------------	--------------	----------------	-----------------

LISTINO € / PEZZO

CORDOLO 6/8 H 25

CRL68	CORDOLO GRIGIO	6-8-100 H 25	40	1600	40
CRV68	CURVA A 90° GRIGIA DIAM. 60 INT.	6-8 H 25	20	480	24
CRL68COLOR	CORDOLO COLORATO	6-8-100 H 25	40	1600	40
CRV68COLOR	CURVA A 90° COLORATA DIAM. 60	6-8 H 25	20	480	24

€ 4,65	PL
€ 9,60	SF
€ 7,80	PL
€ 12,70	SF

CORDOLO 8/8 H 18

CRL88	CORDOLO GRIGIO	8-8-100 H 18	33	1320	40
CRV88	CURVA A 90° GRIGIA DIAM. 60 INT.	8-8 H 18	19	450	24
CRL88COLOR	CORDOLO COLORATO	8-8-100 H 18	33	1320	40
CRV88COLOR	CURVA A 90° COLORATA DIAM. 60	8-8 H 18	19	450	24

€ 4,65	PL
€ 9,60	SF
€ 7,80	PL
€ 12,70	SF

CORDOLO 10/10 H 25

CRL1010	CORDOLO GRIGIO	10-10-100 H 25	55	1275	24
CRV1010	CURVA A 90° GRIGIA DIAM. 80 INT.	10-10 H 25	40	960	24
CRL1010COLOR	CORDOLO COLORATO	10-10-100 H 25	55	1275	24
CRV1010COLOR	CURVA A 90° COLORATA DIAM. 80	10-10 H 25	40	960	24

€ 5,80	PL
€ 12,40	SF
€ 8,90	PL
€ 15,50	SF

CORDOLO 10/12 H 25

CRL1012	CORDOLO GRIGIO	10-12-100 H 25	62	1480	24
CRV1012	CURVA A 90° GRIGIA DIAM. 60 INT.	10-12 H 25	43	780	18
CRL1012COLOR	CORDOLO COLORATO	10-12-100 H 25	62	1480	24
CRV1012COLOR	CURVA A 90° COLORATA DIAM. 60	10-12 H 25	43	780	18

€ 6,60	PL
€ 13,80	SF
€ 9,70	PL
€ 16,90	SF

CORDOLO 12/15 H 25

CRL1215	CORDOLO GRIGIO	12-15-100 H 25	75	1350	18
CRL121533	CORDOLO GRIGIO DA 33	12-15-33 H 25	25	1350	54
CRV1215	CURVA A 90° GRIGIA DIAM. 70 INT.	12-15 H 25	49	740	15
CRL1215COLOR	CORDOLO COLORATO	12-15-100 H 25	75	1350	18
CRL121533COLOR	CORDOLO DA 33 COLORATO	12-15-33 H 25	25	1350	54
CRV1215COLOR	CURVA A 90° COLORATA DIAM. 70	12-15 H 25	49	740	15

€ 8,10	PL
€ 9,10	SF
€ 17,80	SF
€ 10,40	PL
€ 12,30	SF
€ 21,10	SF

CORDOLO 17/20 H 30

CRL1720	CORDOLO GRIGIO	17-20-100 H 30	123	1475	12
CRV1720	CURVA A 90° GRIGIA DIAM. 60 INT.	17-20 H 30	83	1000	12
CRL1720COLOR	CORDOLO COLORATO	17-20-100 H 30	123	1475	12
CRV1720COLOR	CURVA A 90° COLORATA DIAM. 60	17-20 H 30	83	1000	12

€ 27,10	PL
€ 29,70	SF
€ 31,00	PL
€ 32,80	SF

CODICE	PRODOTTO	DIMENSIONI B1*B2*L*H	PESO CAD.	PESO PALLET	PEZZI PALLET
--------	----------	-------------------------	--------------	----------------	-----------------

LISTINO € / PEZZO



VIMINI	CORDOLO IN GETTO TIPO VIMINI	5-5-100 H 25	27	621	23
CURVAVIMINI	CURVA IN GETTO TIPO VIMINI	RAGGIO 50° ANGOLO 90°	30	-	1

€ 10,00	SF
€ 20,00	

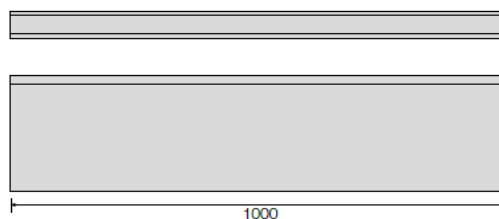

CRLGETTO46	CORDOLO IN GETTO	4-6-100 H 25	27	1134	42
------------	------------------	-----------------	----	------	----

€ 6,65	PL
--------	----

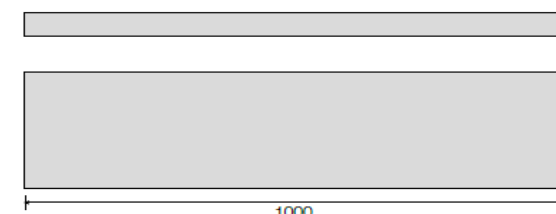
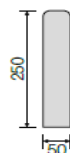

CRLGETTO55	CORDOLO IN GETTO	5-5-100 H 25	27,5	1100	40
------------	------------------	-----------------	------	------	----

€ 7,00	PL
--------	----

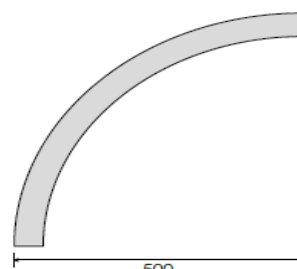
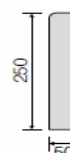

CRVGETTO55	CURVA IN GETTO	5-5 H 25	27	648	24
------------	----------------	-------------	----	-----	----

€ 13,40	SF
---------	----

CORDOLI IN GETTO 6/8 H 15/20/25

CODICE	PRODOTTO	DIMENSIONI B1*B2*L*H	PESO CAD.	PESO PALLET	PEZZI PALLET
--------	----------	-------------------------	--------------	----------------	-----------------

LISTINO € / PEZZO

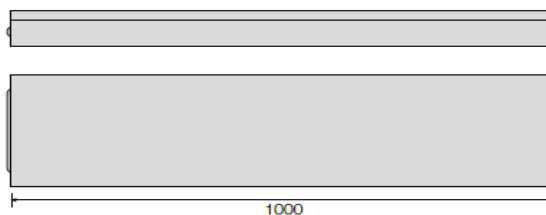
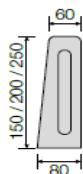

CRLGETTO6815	CORDOLO IN GETTO	6-8-100 H 15	24	1056	44	€ 7,70	PL
CRLGETTO6820	CORDOLO IN GETTO	6-8-100 H 20	33	1452	44	€ 7,70	PL
CRLGETTO68	CORDOLO IN GETTO	6-8-100 H 25	42	1386	33	€ 7,70	PL

€ 7,70	PL
€ 7,70	PL
€ 7,70	PL

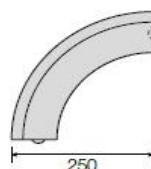
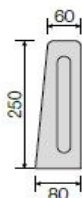

CRVGETTO68PIC	CURVA IN GETTO	6-8 H 25	20	800	40	€ 9,85	SF
---------------	----------------	-------------	----	-----	----	--------	----

€ 9,85	SF
--------	----

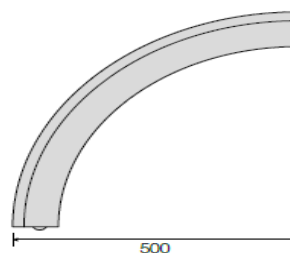
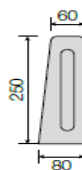

CRVGETTO68	CURVA IN GETTO	6-8 H 25	36	1080	30	€ 14,10	SF
------------	----------------	-------------	----	------	----	---------	----

€ 14,10	SF
---------	----

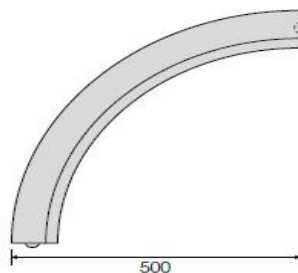
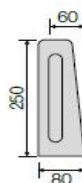

CRVGETTO68ROV	CURVA IN GETTO	6-8 H 25	36	1080	30	€ 14,10	SF
---------------	----------------	-------------	----	------	----	---------	----

€ 14,10	SF
---------	----

CORDOLI IN GETTO 8/10 H 25

CODICE	PRODOTTO	DIMENSIONI B1*B2*L*H	PESO CAD.	PESO PALLET	PEZZI PALLET
--------	----------	-------------------------	--------------	----------------	-----------------

LISTINO € / PEZZO

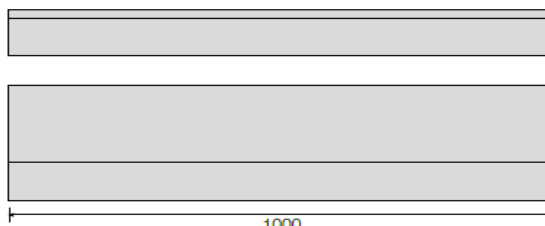
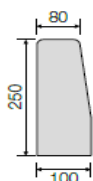

CRLGETTO810	CORDOLO IN GETTO	8-10-100 H 25	55	1650	30
-------------	------------------	------------------	----	------	----

€ 9,40 PL

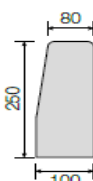

CRVGETTO810PIC	CURVA IN GETTO PICCOLA	8-10 H 25	14	756	54
----------------	------------------------	--------------	----	-----	----

€ 9,50 SF

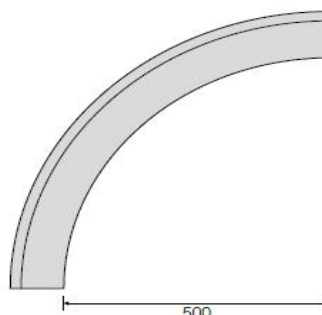

CRVGETTO810	CURVA IN GETTO GRANDE	8-10 H 25	48	1152	24
-------------	-----------------------	--------------	----	------	----

€ 14,70 SF

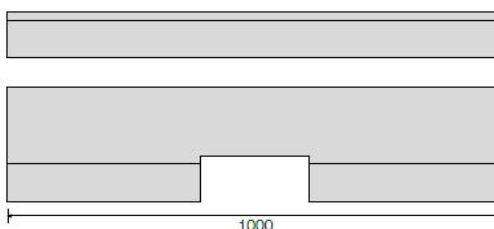
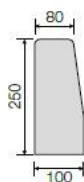

CRLGETTO810LUPO	CORDOLO IN GETTO	8-10-100 H 25	40	1200	30
-----------------	------------------	------------------	----	------	----

€ 11,60 SF

CORDOLI IN GETTO 10/12 H 25

CODICE	PRODOTTO	DIMENSIONI B1*B2*L*H	PESO CAD.	PESO PALLET	PEZZI PALLET
--------	----------	-------------------------	--------------	----------------	-----------------

LISTINO € / PEZZO

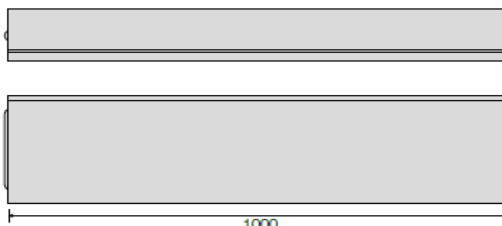
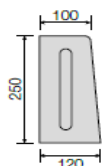

CRLGETTO1012	CORDOLO IN GETTO	10-12-100 H 25	64	1536	24
--------------	------------------	-------------------	----	------	----

€ 10,80	SF
---------	----

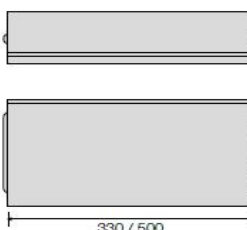
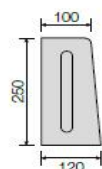

CRLGETTO101233	CORDOLO IN GETTO	10-12-30 H 25	21	1512	72
CRLGETTO101250	CORDOLO IN GETTO	10-12-50 H 25	32	1536	48

€ 8,00	SF
€ 8,70	SF

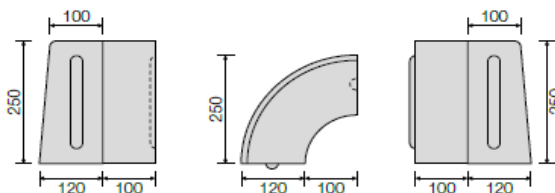

CRLGETTO1012PIC	CURVA IN GETTO	10-12 H 25	17	918	54
-----------------	----------------	---------------	----	-----	----

€ 12,80	SF
---------	----

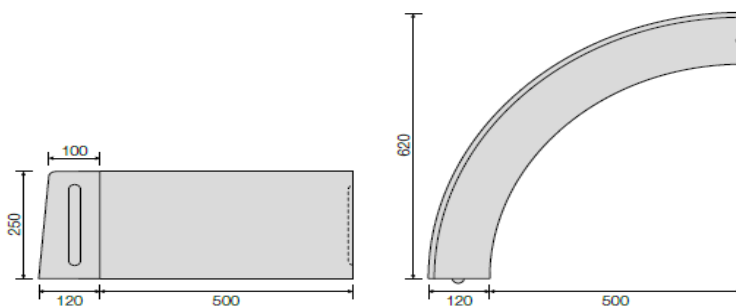

CRVGETTO1012	CURVA IN GETTO	10-12 H 25	56	1008	18
--------------	----------------	---------------	----	------	----

€ 15,40	SF
---------	----

CORDOLI IN GETTO 10/12 H 25

CODICE	PRODOTTO	DIMENSIONI B1*B2*L*H	PESO CAD.	PESO PALLET	PEZZI PALLET
--------	----------	-------------------------	--------------	----------------	-----------------

LISTINO € / PEZZO

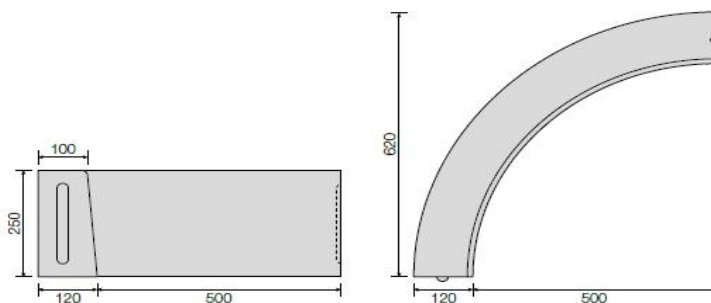

CRVGETTO1012ROV	CURVA IN GETTO ROVESCATA	10-12-100 H 25	56	1008	18
-----------------	-----------------------------	-------------------	----	------	----

€ 15,40 SF

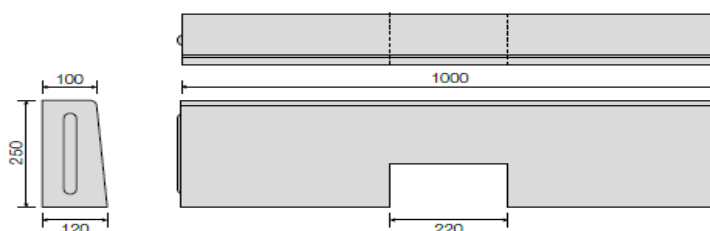

CRLGETTO1012LUP O	CORDOLO IN GETTO	10-12-100 H 25	55	1320	24
----------------------	---------------------	-------------------	----	------	----

€ 12,50 SF

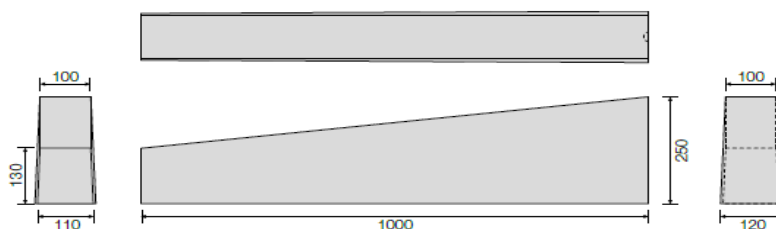

DISCESA1012	DISCESA CARRAIO	10-12-100 H 25/13	48	864	18
-------------	-----------------	----------------------	----	-----	----

€ 10,90 SF

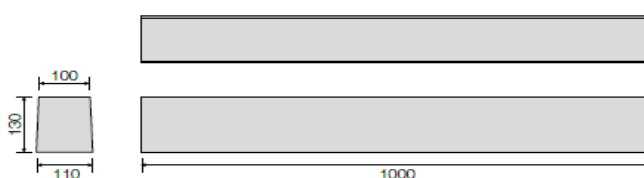

CARRAIO1012	PASSO CARRAIO	10-12-100 H 13	32	1440	45
-------------	---------------	-------------------	----	------	----

€ 10,00 SF

CORDOLI IN GETTO 12/15 H 25

CODICE	PRODOTTO	DIMENSIONI B1*B2*L*H	PESO CAD.	PESO PALLET	PEZZI PALLET
--------	----------	-------------------------	--------------	----------------	-----------------

LISTINO € / PEZZO

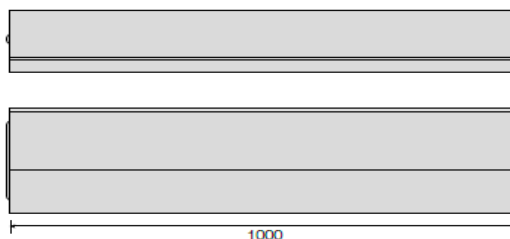
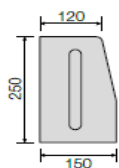

CRLGETTO1215	CORDOLO IN GETTO	12-15-100 H 25	83	1494	18
--------------	------------------	-------------------	----	------	----

€ 12,50	SF
---------	----

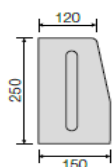

CRLGETTO121533	CORDOLO IN GETTO	12-15-30 H 25	27,5	1485	54
CRLGETTO121550	CORDOLO IN GETTO	12-15-50 H 25	41,5	1494	36

€ 8,40	SF
€ 9,30	SF

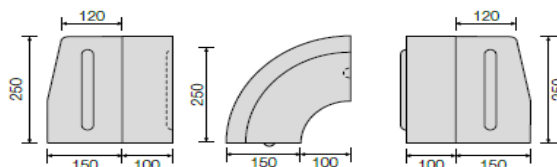

CRVGETTO1215PIC	CURVA IN GETTO	12-15 H 25	26	1170	45
-----------------	----------------	---------------	----	------	----

€ 10,10	SF
---------	----

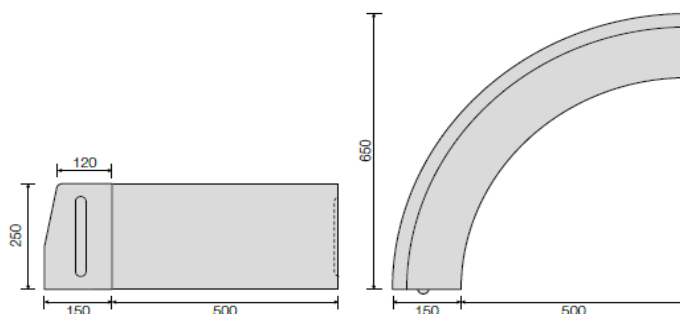

CRVGETTO1215	CURVA IN GETTO	12-15 H 25	75	1350	18
--------------	----------------	---------------	----	------	----

€ 16,20	SF
---------	----

CORDOLI IN GETTO 12/15 H 25

CODICE	PRODOTTO	DIMENSIONI B1*B2*L*H	PESO CAD.	PESO PALLET	PEZZI PALLET
--------	----------	-------------------------	--------------	----------------	-----------------

LISTINO € / PEZZO

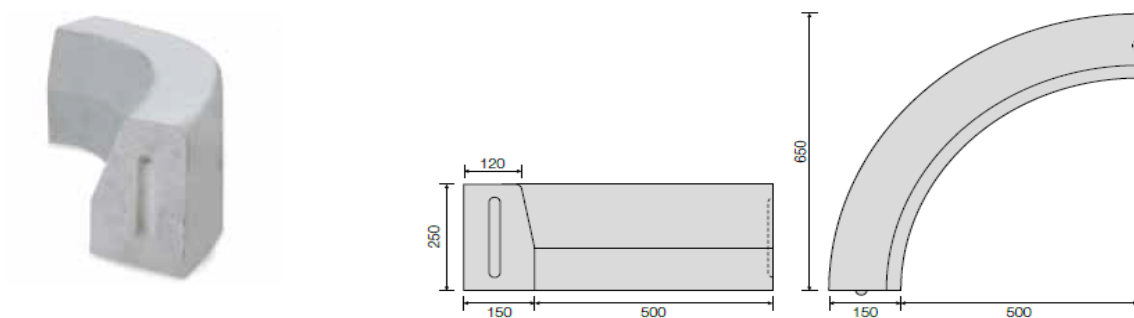

CRVGETTO1215ROV	CURVA IN GETTO ROVESCIAATA	12-15 H 25	75	1350	18
-----------------	-------------------------------	---------------	----	------	----

€ 16,20	SF
---------	----

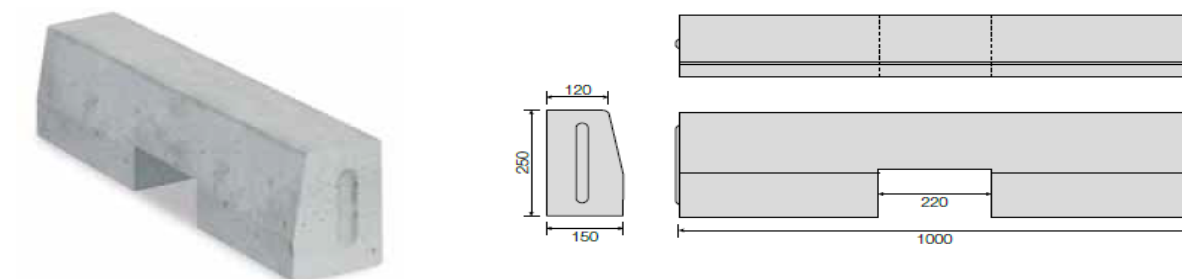

CRLGETTO1215LUP O	CORDOLO IN GETTO	12-15-100 H 25	69	1242	18
----------------------	---------------------	-------------------	----	------	----

€ 13,30	SF
---------	----

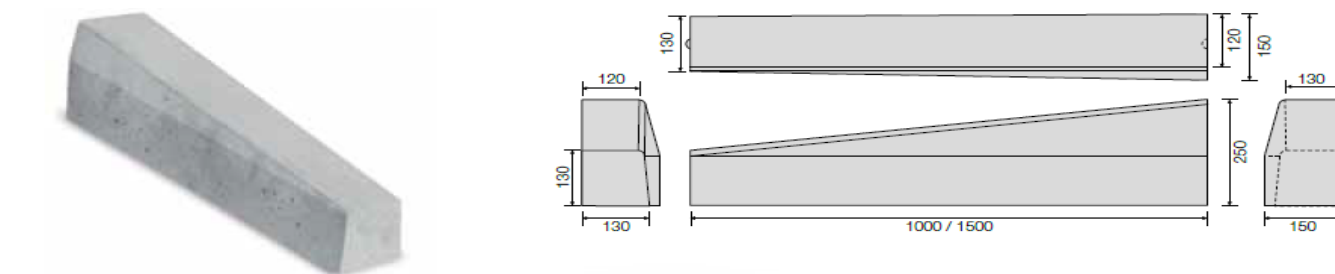

DISCESA1215100	CORDOLO IN GETTO	12-15-100 H 25/13	57	1026	18
DISCESA1215150	CORDOLO IN GETTO	12-15-150 H 25/13	95	1710	18

€ 11,40	SF
€ 19,70	SF

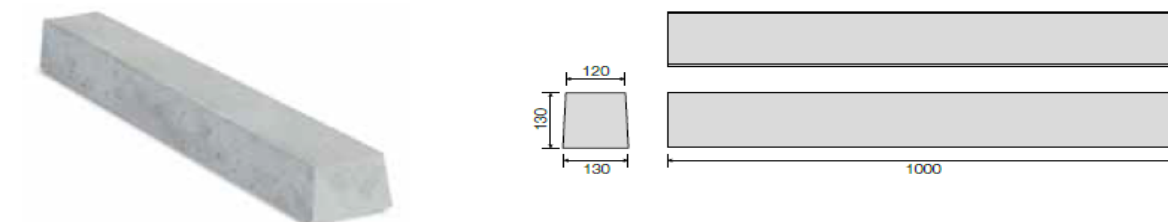

CARRAIO1215	PASSO CARRAIO	12-15-100 H 13	39	1638	42
-------------	---------------	-------------------	----	------	----

€ 10,30	SF
---------	----

CORDOLI IN GETTO 12/15 H 25

CODICE	PRODOTTO	DIMENSIONI B1*B2*L*H	PESO CAD.	PESO PALLET	PEZZI PALLET
--------	----------	-------------------------	--------------	----------------	-----------------

LISTINO € / PEZZO

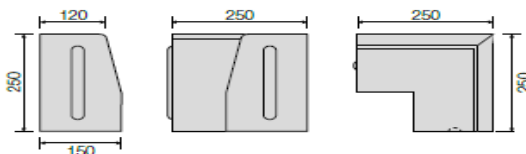

ANGOLO1215PIC	ANGOLO PICCOLO IN GETTO	12-15-25 H 25	35	630	18
---------------	----------------------------	------------------	----	-----	----

€ 19,00 SF

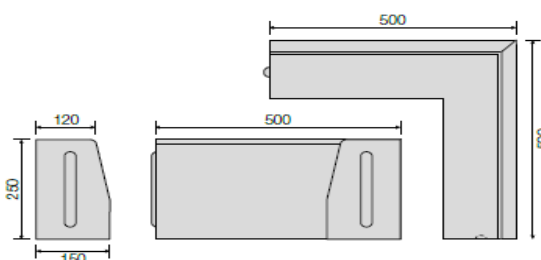

ANGOLO1215	ANGOLO GRANDE IN GETTO	12-15-50 H 25	70	1260	18
------------	---------------------------	------------------	----	------	----

€ 20,70 SF

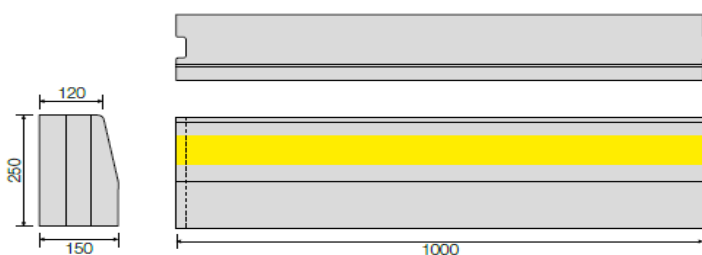

2000RCORA1215	CORDOLO REFLECTA	12-15-100 H 25	83	1494	18
---------------	---------------------	-------------------	----	------	----

€ 37,00 SF

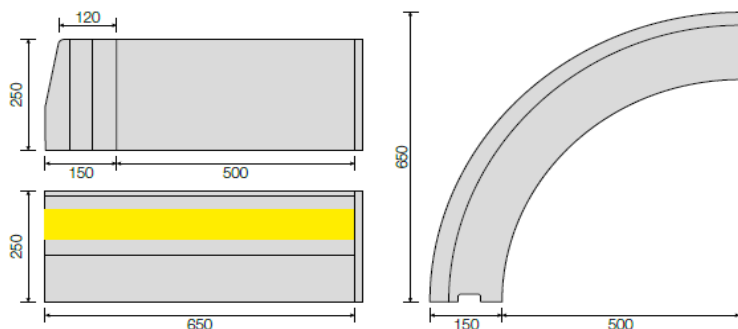

2000RCG1215	CURVA REFLECTA	12-15 H 25	70	1260	18
-------------	----------------	---------------	----	------	----

€ 36,00 SF

CORDOLI IN GETTO 12/15 H 30

CODICE	PRODOTTO	DIMENSIONI B1*B2*L*H	PESO CAD.	PESO PALLET	PEZZI PALLET	LISTINO € / PEZZO
--------	----------	-------------------------	--------------	----------------	-----------------	----------------------

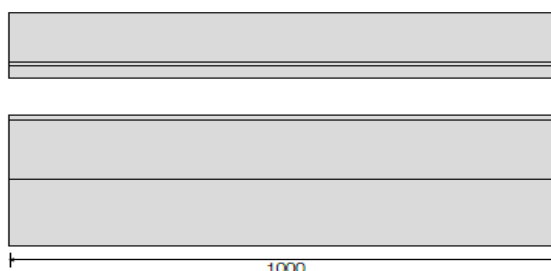
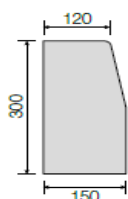

CRLGETTO121530	CORDOLO IN GETTO	12-15-25 H 30	100	1800	18	€ 16,30 SF
----------------	------------------	------------------	-----	------	----	-------------------

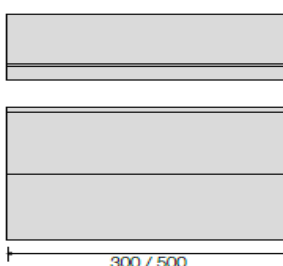
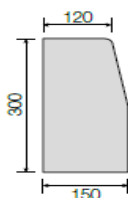

CRVGETTO12153030	CURVA IN GETTO	12-15-30 H 30	33	1782	54	€ 10,30 SF
CRVGETTO12153050	CURVA IN GETTO	12-15-50 H 30	50	1800	36	€ 12,20 SF

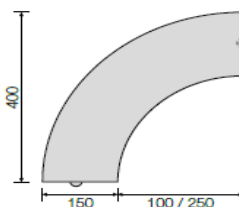
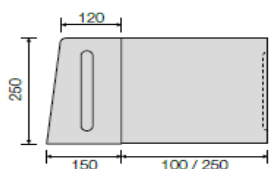

CRVGETTO1215PIC	CURVA IN GETTO	12-15 H 30	34	1530	45	€ 10,60 SF
-----------------	----------------	---------------	----	------	----	-------------------

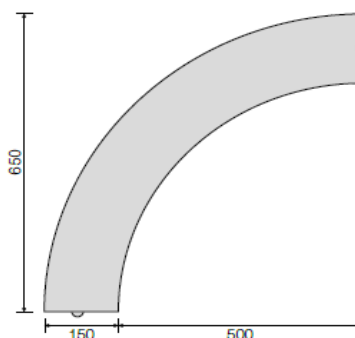
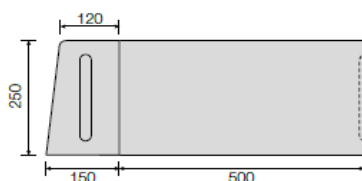

CRVGETTO121530	CURVA IN GETTO	12-15 H 30	92	1380	15	€ 17,20 SF
----------------	----------------	---------------	----	------	----	-------------------

CORDOLI IN GETTO H 35/40/50

CODICE	PRODOTTO	DIMENSIONI B1*B2*L*H	PESO CAD.	PESO PALLET	PEZZI PALLET	LISTINO € / PEZZO
--------	----------	-------------------------	--------------	----------------	-----------------	----------------------

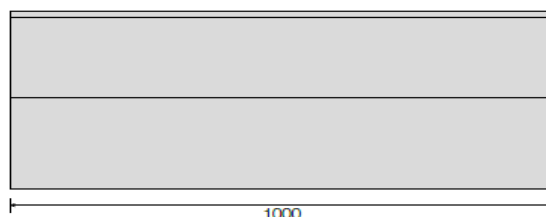
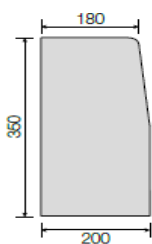

CRLGETTO182035	CORDOLO IN GETTO	18-20-100 H 35	159	1590	10	€ 34,30	SF
CRLGETTO18203530	CORDOLO IN GETTO	18-20-30 H 35	53	1908	36	€ 11,20	SF
CRLGETTO18203550	CORDOLO IN GETTO	18-20-50 H 35	80	1920	24	€ 17,20	SF

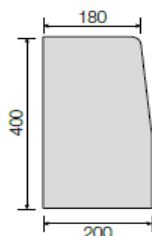

CRLGETTO182040	CORDOLO IN GETTO	18-20-100 H 40	186	1860	10	€ 36,60	SF
CRLGETTO18204030	CORDOLO IN GETTO	18-20-30 H 40	61	2196	36	€ 16,70	SF
CRLGETTO18204050	CORDOLO IN GETTO	18-20-50 H 40	93	2232	24	€ 23,50	SF

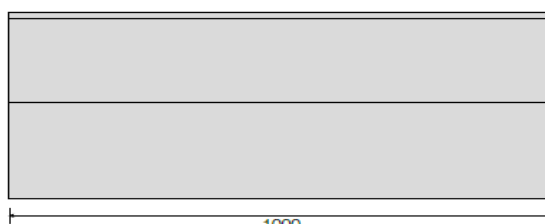
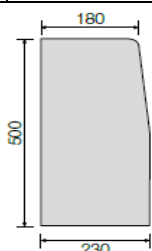

CRLGETTO182350	CORDOLO IN GETTO	18-23-100 H 50	250	1500	6	€ 72,00	SF
----------------	------------------	-------------------	-----	------	---	---------	----

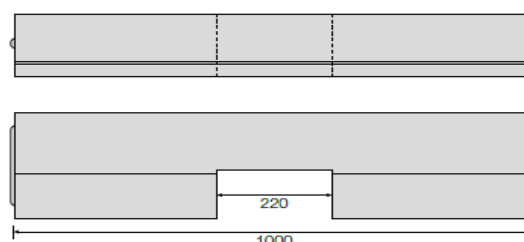
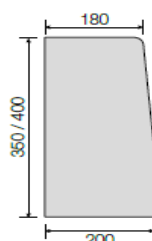

CRLGETTO182035LU PO	CORDOLO IN GETTO	18-20-100 H 35	159	1590	10	€ 40,00	SF
CRLGETTO182040LU PO	CORDOLO IN GETTO	18-20-100 H 40	186	1860	10	€ 42,50	SF

CORDOLI IN GETTO

CODICE	PRODOTTO	DIMENSIONI B1*B2*L*H	PESO CAD.	PESO PALLET	PEZZI PALLET
--------	----------	-------------------------	--------------	----------------	-----------------

LISTINO € / PEZZO

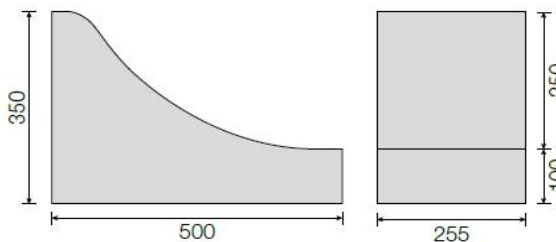

OLANDESE	CORDOLO ALL' OLANDESE	25,5-500 H 35	61	1464	24
----------	-----------------------	------------------	----	------	----

€ 16,80	SF
---------	----

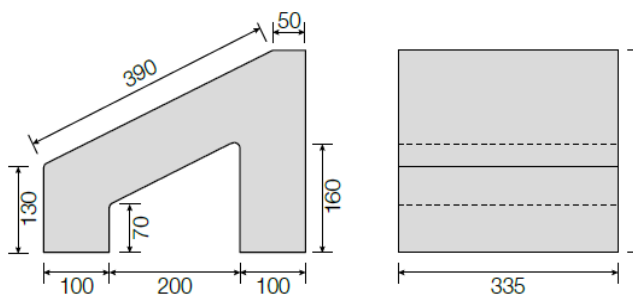

ANAS	CORDOLO ANAS	33,5-13-30 H 40	54	1944	36
------	--------------	--------------------	----	------	----

€ 15,50	SF
---------	----

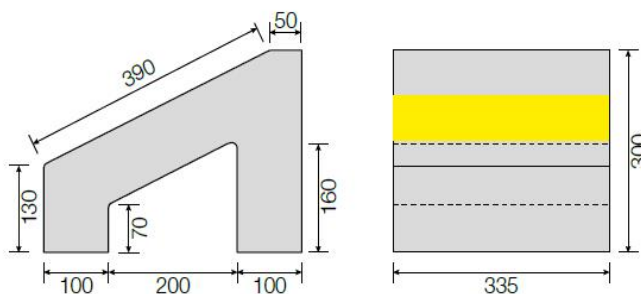

2000RCORANAS	CORDOLO ANAS REFLECTA	33,5-13-30 H 40	54	1944	36
--------------	-----------------------	--------------------	----	------	----

€ 35,70	SF
---------	----

CUNETTA ALLA FRANCESE

CODICE	PRODOTTO	DIMENSIONI B1*B2*L*H	PESO CAD.	PESO PALLET	PEZZI PALLET
--------	----------	-------------------------	--------------	----------------	-----------------

LISTINO € / PEZZO

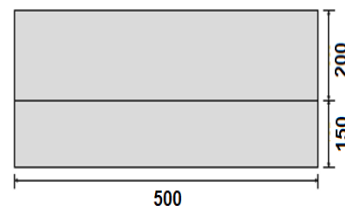
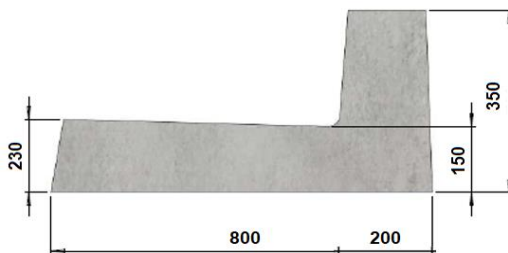

CUNFRANC	CUNETTA ALLA FRANCESE VIBRATA	17-20-50 H 35	300	1200	4
----------	-------------------------------	------------------	-----	------	---

€ 85,00 SF

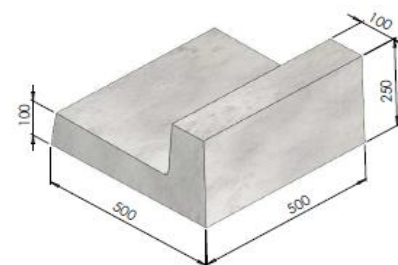
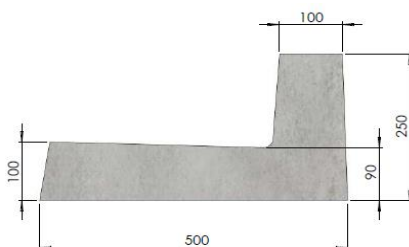

CUNFRANC	CUNETTA ALLA FRANCESE	10-12-50 H 25	73	1752	24
----------	-----------------------	------------------	----	------	----

€ 14,90 SF

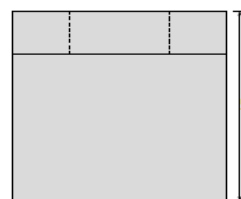
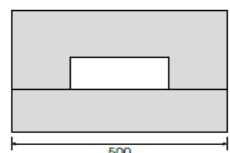
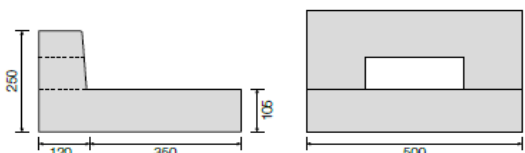

CORBL1012	CUNETTA ALLA FRANCESE	10-12-50 H 25	70	1680	24
-----------	-----------------------	------------------	----	------	----

€ 20,00 SF

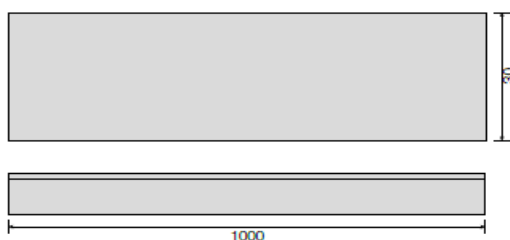
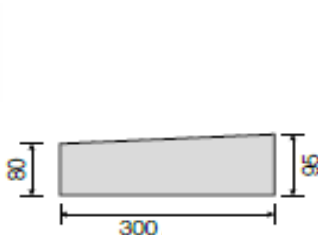

2200CUN30	CUNETTA FRANCESE SENZA CORDOLO	30-100 H 8/9,5	63	1890	30
-----------	--------------------------------	-------------------	----	------	----

€ 13,20 SF

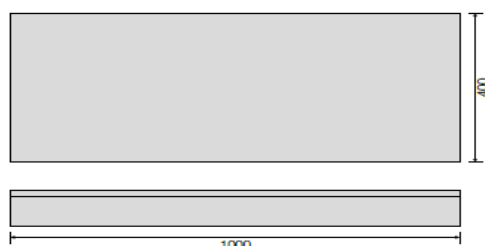
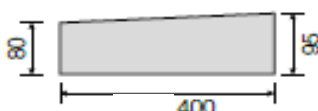

2200CUN40	CUNETTA FRANCESE SENZA CORDOLO	40-100 H 8/9,5	84	1680	20
-----------	--------------------------------	-------------------	----	------	----

€ 16,00 SF

CUNETTA ALL' ITALIANA

CODICE	PRODOTTO	DIMENSIONI B1*B2*L*H	PESO CAD.	PESO PALLET	PEZZI PALLET
--------	----------	-------------------------	--------------	----------------	-----------------

LISTINO € / PEZZO

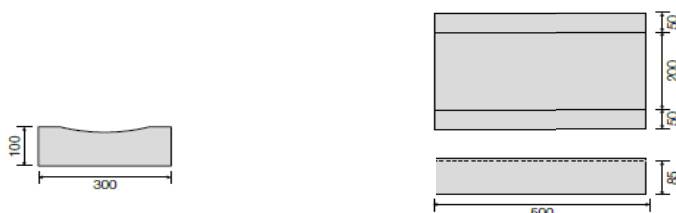
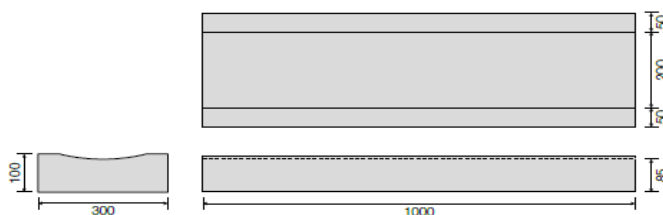

CUNITAL	CUNETTA ALL' ITALIANA	30-100 H 10	60	1260	21	€ 13,80
CADITITAL	CADITOIA ALL' ITALIANA	30-50 H 10	30	-	1	€ 21,00

€ 13,80	SF
€ 21,00	

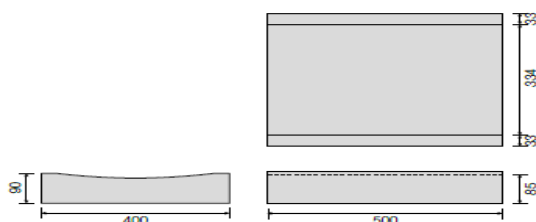
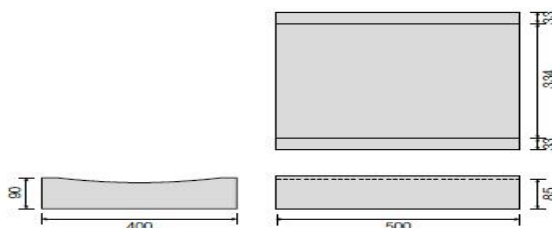

CUNITAC	CUNETTA ALL' ITALIANA	40-50 H 9	34	1224	36	€ 10,30
CADITITAC	CADITOIA ALL' ITALIANA	40-50 H 9	34	-	1	€ 21,00

€ 10,30	SF
€ 21,00	

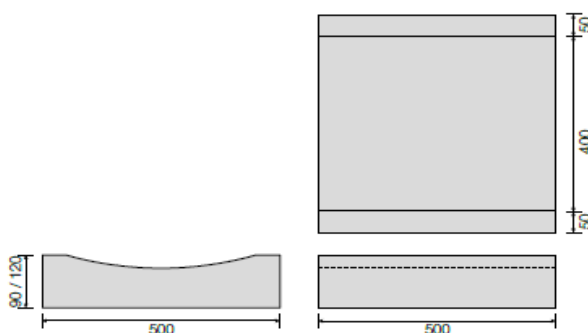

CUNITA50	CADITOIA ALL' ITALIANA	50-50 H 12	56	1120	20	€ 12,60
----------	------------------------	---------------	----	------	----	---------

€ 12,60	SF
---------	----

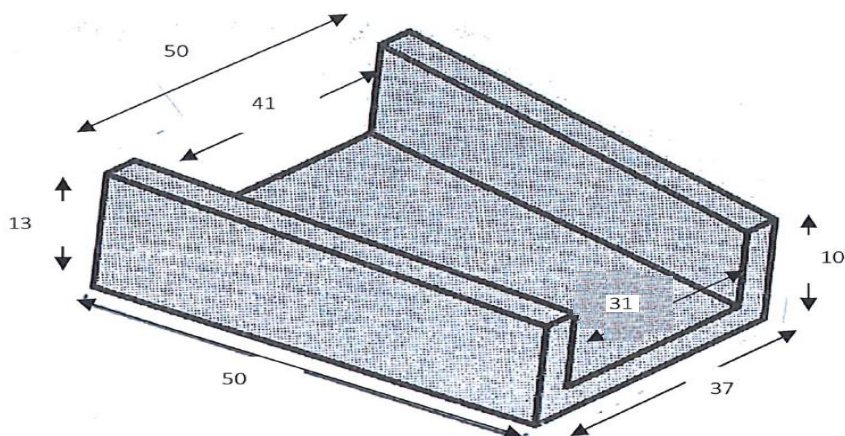
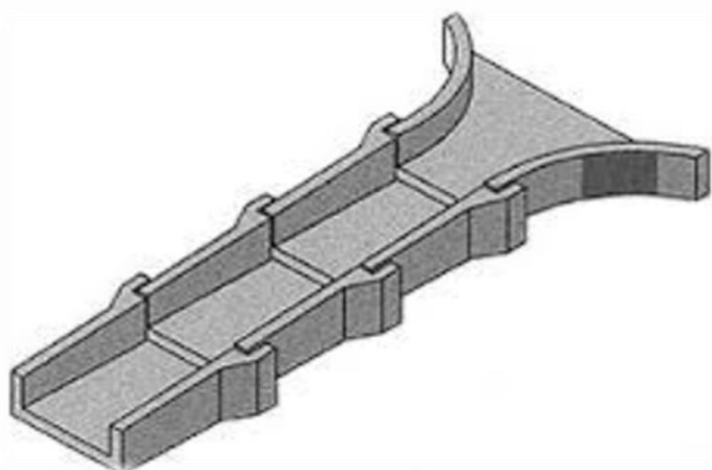

EMBRICE

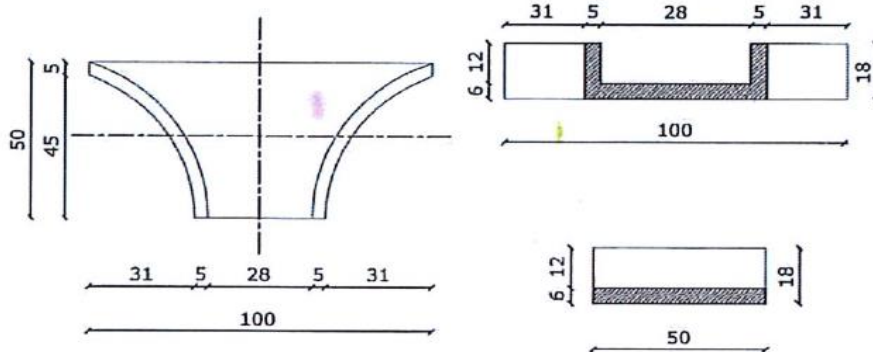

IMBOCCO

CODICE	PRODOTTO	DIMENSIONI ESTERNE B*L*H	DIMENSIONI INTERNE B*L*H	PESO CAD.	PEZZI PALLET	LISTINO € / PEZZO
EMBRICE	CUNETTA PER SCARPATA	50-37 H 13	41-31 H 10	25	32	€ 13,50 SF
IMBOCCOEMBR	IMBOCCO CUNETTA	100-50 H 18	90-28 H 12	50	1	€ 37,80 SF

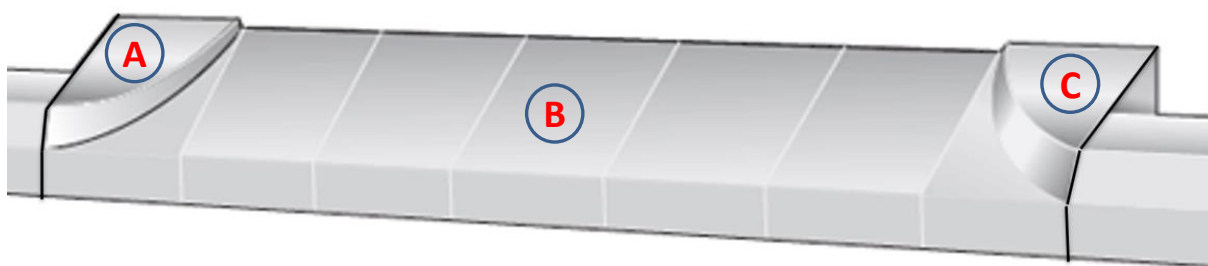

CODICE	PRODOTTO	DIMENSIONI B*L*H	PESO CAD.	PESO PALLET	PEZZI PALLET	LISTINO € / PEZZO
--------	----------	---------------------	--------------	----------------	-----------------	----------------------



A SINISTRO
C DESTRO

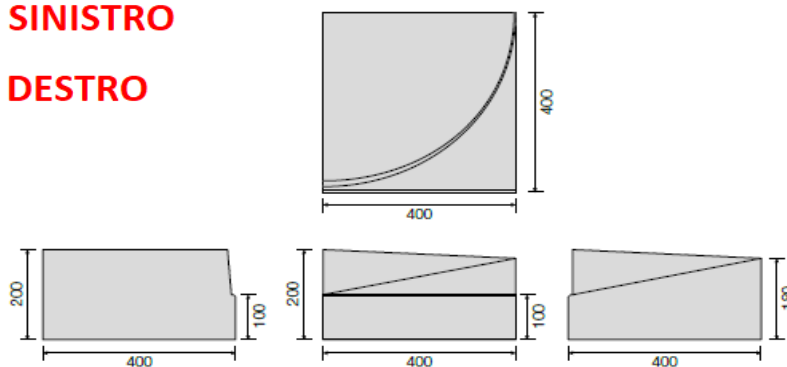

VOLTAT	VOLTA TESTA PASSO CARRAIO	40-40 H 20	50	1200	24	€ 16,60 SF
--------	------------------------------	---------------	----	------	----	-------------------

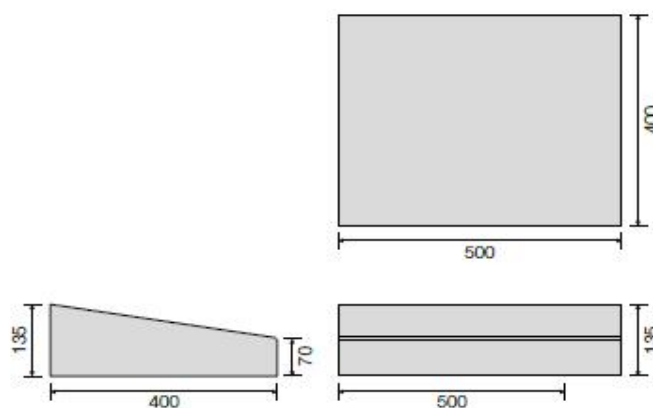

PASSOCAR	PASSO CARRAIO	40-50 H 13,5	46	1656	36	€ 14,30 SF
----------	---------------	-----------------	----	------	----	-------------------



CODICE	PRODOTTO	DIMENSIONI DIAM.*H	PESO CAD.	COLORE	PEZZI PALLET	LISTINO € / PEZZO
--------	----------	-----------------------	--------------	--------	-----------------	----------------------

DISSUASORE	DISSUASORE CON	DIAM. * H	PESO	COLORE	PEZZI	LISTINO	
DISSUASORE GOLFARE	CON	DIAM. 47 H 50	175	-	4	1	€ 65,50 SF
DISSUAFORO	DISSUASORE CON FORO DA 6 CM	DIAM. 47 H 50	175	-	4	2	€ 65,50 SF
DISSUACOLOR	DISSUASORE COLORATO CON GOLFARE	DIAM. 47 H 50	175	GIALLO		3	€ 114,00
DISSUACAT	DISSUASORE CON CATARIFRANGENTE	DIAM. 53 H 53	215	-		4	€ 140,00
200	DISSUASORE GHIAIA LAVATA COLORE GRIGIO	DIAM.53 H 60	225	GRIGIO		5	€ 230,00
200c	DISSUASORE GHIAIA LAVATA COLORE AVORIO	DIAM.53 H 60	225	AVORIO		6	€ 230,00
200GC	DISSUASORE CUBO GRIGIO CEMENTO	40 X 40 H 40	150	CEMENTO		7	€ 170,00
205	DISSUASORE CUBO GHIAIA LAVATA COLORE GRIGIO	40 X 40 H 40	150	GRIGIO		7	€ 230,00
205c	DISSUASORE CUBO GHIAIA LAVATA COLORE AVORIO	40 X 40 H 40	150	AVORIO		7	€ 230,00
201GC	DISSUASORE CAMPANA GRIGIO CEMENTO	DIAM.45 H 75	150	CEMENTO		8	€ 170,00
200CG	DISSUASORE CAMPANA GHIAIA LAVATA COLORE GRIGIO	DIAM.45 H 75	150	GRIGIO		8	€ 230,00
200CC	DISSUASORE CAMPANA GHIAIA LAVATA COLORE AVORIO	DIAM.45 H 75	150	AVORIO		8	€ 230,00
202GC	DISSUASORE A BOCCIA GRIGIO CEMENTO	DIAM.50 H 70	190	CEMENTO		9	€ 170,00
200BC	DISSUASORE A BOCCIA GHIAIA LAVATA COLORE GRIGIO	DIAM.50 H 70	190	GRIGIO		9	€ 230,00
200BG	DISSUASORE A BOCCIA GHIAIA LAVATA COLORE AVORIO	DIAM.50 H 70	190	AVORIO		9	€ 230,00
300	DISSUASORE CAMPANA	DIAM.50 H 80	175	CEMENTO		10	€ 200,00
301	DISSUASORE CAMPANA CON CATARIFRANGENTE	DIAM.50 H 80	175	-		11	€ 230,00

M E R C E
S U
O R D I N A Z I O N E

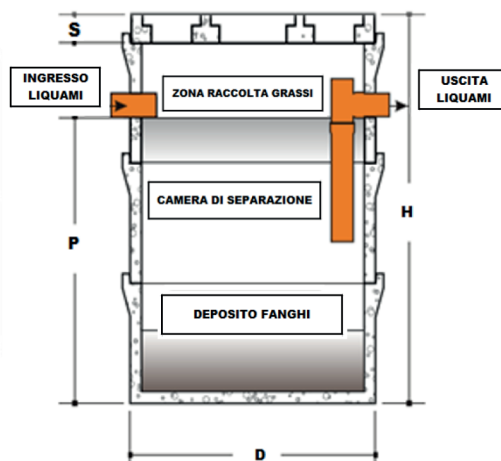

CONDENSAGRASSI 60 / 80 / 100

CONDENSAGRASSI 150 - 200

CODICE	PRODOTTO	DIMENSIONI DIAM. INT. * H	PESO CAD.	NUMERO PERSONE	VOLUME LITRI	PASTI GIORNALIERI	LISTINO € / PEZZO
COND60	FOSSA CONDENSAGRASSI	DIAM. 60 H 75	300	3 - 4	120	10	€ 53,50
COND80	FOSSA CONDENSAGRASSI	DIAM. 80 H 80	500	4 - 8	450	20	€ 92,40
COND100	FOSSA CONDENSAGRASSI	DIAM.100 H 100	800	8 - 13	630	30	€ 186,00
COND150	FOSSA CONDENSAGRASSI	DIAM.150 H 150	1600	20 - 30	2200	75	€ 320,00
COND200	FOSSA CONDENSAGRASSI	DIAM.200 H 200	3030	30 - 50	5500	150	€ 850,00

FOSSA DISOLEATRICI - DISSABBIATORE



* LE SOLETTE SONO A PAG.46

*** PER IL DIMENSIONAMENTO DEI DISOLEATORI POSTI IN PIAZZALI / OFFICINE
E' DOVEROSO RIVOLGERSI AL PROGETTISTA ,PER IL CALCOLO DEI LITRI NECESSARI.**

CODICE	PRODOTTO	DIMENSIONI DIAMETRO INTERNO * H	PESO CAD.	CAPACITA' TOTALE LITRI	NOTE INDICATIVE	LISTINO € / PEZZO
CDISOL100	FOSSA DISOLEATRICE	DIAM. 100 H 100	800	700	16 GARAGES	€ 280,00
CDISOL150	FOSSA DISOLEATRICE	DIAM. 150 H 100	1740	1590	35 GARAGES	€ 720,00

NORME PER FOSSE CONDENSAGRASSI - DISOLEATORE



GLI ASPETTI LEGISLATIVI CHE RIGUARDANO I CONDENSAGRASSI SONO :

- DAL SUPPLEMENTO ALLA GAZZETTA UFFICIALE DEL 21 FEBBRAIO 1977 - MINISTERO DEI LAVORI PUBBLICI - COMITATO DEI MINISTRI PER LA TUTELA DELLE ACQUE DELL' INQUINAMENTO "CRITERI",METODOLOGIE E NORME TECNICHE GENERALI DI CUI ALL'ART.2,LETTERA B),D) ED E),DELLA LEGGE 10 MAGGIO 1976, N.319, RECANTE NORME PER LA TUTELA DELLE ACQUE DALL' INQUINAMENTO.
 - DALLA LEGGE 10 MAGGIO 1976,N.319 "NORME PER LA TUTELA DELLE ACQUE DALL'INQUINAMENTO" LEGGE MERLI (1) E SUCCESSIVE MODIFICHE ED INTEGRAZIONI.
 - DAL D.L.GS. 152/1999 RECANTE DISPOSIZIONI SULLA TUTELA DELLE ACQUE DALL'INQUINAMENTO E RECEPIMENTO DELLA DIRETTIVA 91/271/CEE CONCERNENTE IL TRATTAMENTO DELLE ACQUE REFLUE URBANE E DELLA DIRETTIVA 91/676/CEE RELATIVA ALLA PROTEZIONE DELLE ACQUE DALL'INQUINAMENTO PROVOCATO DAI NITRATI PROVENIENTI DA FONTI AGRICOLE.
 - DAL D.L.GS. 152/2006 "NORME IN MATERIA AMBIENTALE" PARTE TERZA NORME IN MATERIA DI DIFESA DEL SUOLO E LOTTA ALLA DESERTIFICAZIONE, DI TUTELA DELLE ACQUE DALL'INQUINAMENTO E DI GESTIONE DELLE RISORSE IDRICHE.
 - DAL SUPPLEMENTO ORDINARIO N. 30 DELLA GAZZETTA UFFICIALE N. 29 DEL 4 FEBBRAIO 2008 - MINISTERO DELLE INFRASTRUTTURE - D.M. 14 GENNAIO 2008, RECANTE "NUOVE NORME TECNICHE PER LE COSTRUZIONI".
 - T.U "NORME TECNICHE PER LE COSTRUZIONI" ASSEMBLEA GENERALE DEL CONSIGLIO SUPERIORE DEI LAVORI PUBBLICI DEL 30 MARZO 2005.
- I CONDENSAGRASSI SONO CONFORMI ALLA SEGUENTE LEGISLATIVA SPECIFICA:
- DELIBERAZIONE DELLA GIUNTA REGIONALE N. 1053/2003 DEL 09.06.2003 "DIRETTIVA CONCERNENTE INDIRIZZI PER L'APPLICAZIONE DEL D.L.GS. 152/99 IN MATERIA DI TUTELA DELLE ACQUE DALL'INQUINAMENTO".

I CONDENSAGRASSI SONO REGOLATI DALLE NORME DIN 4040 CHE SONO STATE IN GRAN PARTE RECEPITE DA:

- NORMA EUROPEA UNI EN 1825-1:2005.
TALE NORMA, CHE HA PORTATO IN ITALIA UN NOTEVOLE CAMBIAMENTO DI MENTALITA', RIGUARDA ESCLUSIVAMENTE GLI SCARICHI CONTENENTI OLI/GRASSI D'ORIGINE ANIMALE E VEGETALE. I SEPARATORI STATICI DI OLI/GRASSI DEVONO ESSERE UTILIZZATI OGNI QUALVOLTA E' NECESSARIO SEPARARE GLI OLI ED I GRASSI ANIMALI E VEGETALI DALLE ACQUE REFLUE PER MEZZO DELLA GRAVITA' E SENZA FONTI ENERGETICHE ESTERNE. TALE NORMA EUROPEA, QUINDI, CONSIDERANDO, IN GENERALE, LE CUCINE, RIGUARDA LE ACQUE DI SCARICO DELLE LAVASTOVIGLIE E, PIU' COMUNEMENTE, TUTTE LE ACQUE DI SCARICO USATE PER TENERE PULITE LE ATTREZZATURE E LE CUCINE STESSE. LA NORMA SPECIFICA LE DEFINIZIONI, DIMENSIONI NOMINALI, PRINCIPI DI PRESTAZIONE, MARCATURA, PROVE E CONTROLLO QUALITA'.
INOLTRE IL CONDENSAGRASSI E' PRODOTTO, CONTROLLATO E CERTIFICATO DALLA SEGUENTE NORMA:
- NORMA UNI EN 206-1:2006
PRODOTTI IN CALCESTRUZZO. LA PRESENTE NORMA SI APPLICA AL CALCESTRUZZO PER STRUTTURE GETTATE IN SITU, STRUTTURE PREFABBRICATE E COMPONENTI STRUTTURALI PREFABBRICATI PER EDIFICI E STRUTTURE DI INGEGNERIA CIVILE. IL CALCESTRUZZO PUO' ESSERE CONFEZIONATO IN CANTIERE, PRECONFEZIONATO O PRODOTTO IN UN IMPIANTO PER COMPONENTI DI CALCESTRUZZO PREFABBRICATO.
- IL PROCESSO DI FABBRICAZIONE (PER QUANTO APPLICABILE) RISPETTOSO DI QUANTO RICHIESTO DALLA DIRETTIVA 89/106/CEE (RECEPITA CON DPR 246/1993 DEL 21/04/1993) E SUCCESSIVE MODIFICHE ED INTEGRAZIONI.

GLI ASPETTI LEGISLATIVI CHE RIGUARDANO I DISOLEATORI SONO :

- DAL SUPPLEMENTO ALLA GAZZETTA UFFICIALE DEL 21 FEBBRAIO 1977 - MINISTERO DEI LAVORI PUBBLICI - COMITATO DEI MINISTRI PER LA TUTELA DELLE ACQUE DELL' INQUINAMENTO "CRITERI",METODOLOGIE E NORME TECNICHE GENERALI DI CUI ALL'ART.2,LETTERA B),D) ED E),DELLA LEGGE 10 MAGGIO 1976, N.319,RECANTE NORME PER LA TUTELA DELLE
 - DALLA LEGGE 10 MAGGIO 1976,N.319 "NORME PER LA TUTELA DELLE ACQUE DALL'INQUINAMENTO" LEGGE MERLI (1) E SUCCESSIVE MODIFICHE ED INTEGRAZIONI.
 - DAL D.L.GS. 152/1999 RECANTE DISPOSIZIONI SULLA TUTELA DELLE ACQUE DALL'INQUINAMENTO E RECEPIMENTO DELLA DIRETTIVA 91/271/CEE CONCERNENTE IL TRATTAMENTO DELLE ACQUE REFLUE URBANE E DELLA DIRETTIVA 91/676/CEE RELATIVA ALLA PROTEZIONE DELLE ACQUE DALL'INQUINAMENTO PROVOCATO DAI NITRATI PROVENIENTI DA FONTI AGRICOLE.
 - DAL D.L.GS. 152/2006 "NORME IN MATERIA AMBIENTALE" PARTE TERZA NORME IN MATERIA DI DIFESA DEL SUOLO E LOTTA ALLA DESERTIFICAZIONE, DI TUTELA DELLE ACQUE DALL'INQUINAMENTO E DI GESTIONE DELLE RISORSE IDRICHE.
VENGONO DATE LE DEFINIZIONI DI
A) "ABITANTE EQUIVALENTE": IL CARICO ORGANICO BIODEGRADABILE AVENTE UNA RICHIESTA BIOCHIMICA DI OSSIGENO A 5 GIORNI (BOD5) PARI A 60 GRAMMI DI OSSIGENO AL GIORNO;
B) "TRATTAMENTO PRIMARIO" CIOE' IL TRATTAMENTO DELLE ACQUE REFLUE URBANE MEDIANTE UN PROCESSO FISICO OVVERO CHIMICO CHE COMPORTE LA SEDIMENTAZIONE DEI SOLIDI SOSPESI, OVVERO MEDIANTE ALTRI PROCESSI A SEGUITO DEI QUALI IL BOD5 DELLE ACQUE REFLUE IN ARRIVO SIA RIDOTTO ALMENO DEL 20% PRIMA DELLO SCARICO E I SOLIDI SOSPESI TOTALI DELLE ACQUE REFLUE IN ARRIVO SIANO RIDOTTI ALMENO DEL 50%.
 - DAL SUPPLEMENTO ORDINARIO N. 30 DELLA GAZZETTA UFFICIALE N. 29 DEL 4 FEBBRAIO 2008 - MINISTERO DELLE INFRASTRUTTURE - D.M. 14 GENNAIO 2008, RECANTE "NUOVE NORME TECNICHE PER LE COSTRUZIONI".
 - T.U "NORME TECNICHE PER LE COSTRUZIONI" ASSEMBLEA GENERALE DEL CONSIGLIO SUPERIORE DEI LAVORI PUBBLICI DEL 30 MARZO 2005.
- IL DISOLEATORE E' PRODOTTO, CONTROLLATO E CERTIFICATO DALLE SEGUENTI NORME:
- UNI EN 858-1:2005
IMPIANTI DI SEPARAZIONE PER LIQUIDI LEGGERI (PER ESEMPIO BENZINA E PETROLIO) - PARTE 1: PRINCIPI DI PROGETTAZIONE, PRESTAZIONE E PROVE SUL PRODOTTO, MARCATURA E CONTROLLO QUALITA'; UNI EN 858-2:2004 IMPIANTI DI SEPARAZIONE PER LIQUIDI LEGGERI (PER ESEMPIO BENZINA E PETROLIO)
 - SCELTA DELLE DIMENSIONI NOMINALI, INSTALLAZIONE, ESERCIZIO E MANUTENZIONE.
 - NORMA UNI EN 206-1:2006
PRODOTTI IN CALCESTRUZZO. LA PRESENTE NORMA SI APPLICA AL CALCESTRUZZO PER STRUTTURE GETTATE IN SITU, STRUTTURE PREFABBRICATE E COMPONENTI STRUTTURALI PREFABBRICATI PER EDIFICI E STRUTTURE DI INGEGNERIA CIVILE. IL CALCESTRUZZO PUO' ESSERE CONFEZIONATO IN CANTIERE, PRECONFEZIONATO O PRODOTTO IN UN IMPIANTO PER COMPONENTI DI CALCESTRUZZO PREFABBRICATO.
 - IL PROCESSO DI FABBRICAZIONE (PER QUANTO APPLICABILE) RISPETTOSO DI QUANTO RICHIESTO DALLA DIRETTIVA 89/106/CEE (RECEPITA CON DPR 246/1993 DEL 21/04/1993) E SUCCESSIVE MODIFICHE ED INTEGRAZIONI.
 - UNI EN 12056-2:2001
SISTEMI DI SCARICO FUNZIONANTI A GRAVITA' ALL'INTERNO DEGLI EDIFICI - IMPIANTI PER ACQUE REFLUE, PROGETTAZIONE E CALCOLO.
LA NORMA SI APPLICA AI SISTEMI FOGNARI PER LO SMALTIMENTO DELLE ACQUE REFLUE CHE FUNZIONANO A GRAVITA'. ESSA SI APPLICA AI SISTEMI FOGNARI ALL'INTERNO DI ABITAZIONI, EDIFICI COMMERCIALI, EDIFICI PUBBLICI E INDUSTRIALI.
LA SECONDA PARTE DELLA NORMA STABILISCE I PRINCIPI DA SEGUIRE SIA PER LA PROGETTAZIONE SIA PER IL CALCOLO.

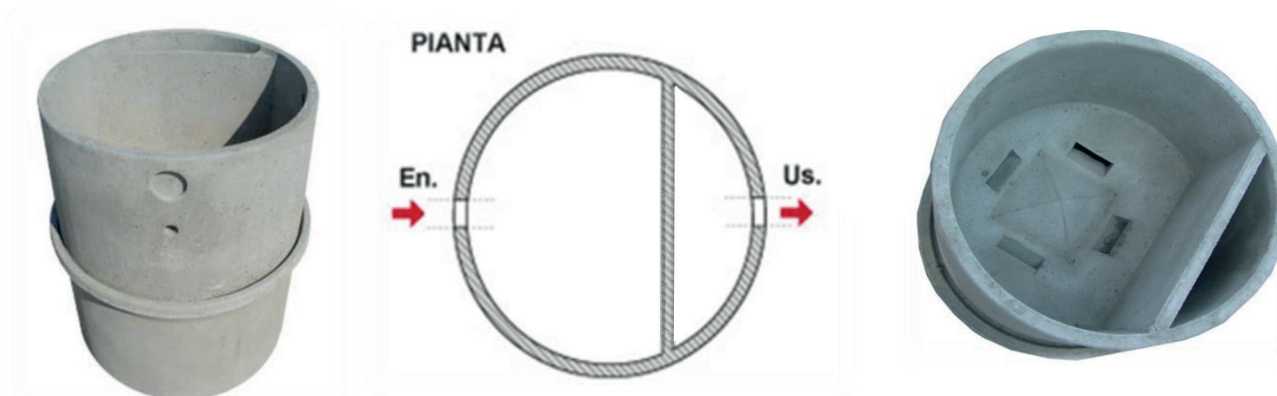

*** LE SOLETTE SONO A PAG.46**

DIAFRAMMA

CODICE	PRODOTTO DIAMETRO INTERNO	DIMENSIONI DIAMETRO ESTERNO * H	PESO CAD.	PERSONE	NOTE	LISTINO € / PEZZO
CFOSSA3	FOSSA IMHOFF DIAM. 80 INTERNO	DIAM, 90 H 150	660	3 - 4	2 ELEMENTI	€ 190,00
CFOSSA8	FOSSA IMHOFF DIAM. 100 INTERNO	DIAM, 110 H 160	1160	4 - 8	2 ELEMENTI	€ 190,00
CFOSSA10	FOSSA IMHOFF DIAM. 150 INTERNO	DIAM, 163 H 130	1900	6-10	2 ELEMENTI	€ 540,00
CFOSSA15	FOSSA IMHOFF DIAM. 150 INTERNO	DIAM, 163 H 180	2600	10-15	3 ELEMENTI	€ 630,00
CFOSSA20	FOSSA IMHOFF DIAM. 200 INTERNO	DIAM, 216 H 180	4330	17-25	3 ELEMENTI	€ 1.275,00
CFOSSA25	FOSSA IMHOFF DIAM. 200 INTERNO	DIAM, 216 H 230	5130	26-34	4 ELEMENTI	€ 1.640,00
CFOSSA40	FOSSA IMHOFF DIAM. 200 INTERNO	DIAM, 216 H 280	5890	35-42	5 ELEMENTI	€ 1.820,00
CFOSSA60	FOSSA IMHOFF DIAM. 200 INTERNO	DIAM, 216 H 330	6690	43-58	6 ELEMENTI	€ 2.130,00

PRODOTTO	DIMENSIONI DIAM. EST. * H	DIGESTIONE LITRI	SEDIMENTAZIONE LITRI	TEMPI DI SPURGO	
				1 / ANNO	2 / ANNO
FOSSA IMHOFF DIAM. 80	90 H 160	500	190	3	4
FOSSA IMHOFF DIAM. 100	110 H 160	540	360	4	8
FOSSA IMHOFF DIAM. 150	163 H 130	777	592	6	10
FOSSA IMHOFF DIAM. 150	163 H 180	1660	592	10	15
FOSSA IMHOFF DIAM. 200	216 H 180	3000	1055	17	25
FOSSA IMHOFF DIAM. 200	216 H 230	4570	1055	26	34
FOSSA IMHOFF DIAM. 200	216 H 280	4570	2355	35	42
FOSSA IMHOFF DIAM. 200	216 H 330	6140	2355	43	58

FOSSE TIPO IMHOFF

GENERALITA'

UTILIZZATE PER LA CHIARIFICAZIONE E LO SMALTIMENTO DEI LIQUAMI PROVENIENTI DAGLI INSEDIAMENTI CIVILI, LE NOSTRE FOSSE IMHOFF SONO PRODOTTE SECONDO LE PRESCRIZIONI DELLA NORMATIVA VIGENTE, CON L' USO DI MATERIALI A QUALITA' CERTIFICATA.

SONO COMPOSTE DA DUE SCOMPARTI UNO SUPERIORE DI SEDIMENTAZIONE DOVE SI ACCUMULANO IN SUPERFICIE LE SOSTANZE PIU' LEGGERE E UNO INFERIORE DI DIGESTIONE DOVE SI RACCOLGONO, PER CADUTA NATURALE, LE SOSTANZE SEDIMENTATE CHE SI ACCUMULANO NEL FONDO.

PER AUMENTARE LA CAPACITA' DELLA FOSSA OCCORRE PORRE UNO O PIU' ANELLI DI PROLUNGA DOPO AVER POSATO IL FONDO.

LE FOSSE DEVONO ESSERE RIEMPIE D' ACQUA PRIMA DELLA LORO MESSA IN FUNZIONE PER UN BUON FUNZIONAMENTO DELLA FOSSA STESSA.

POSA IN OPERA

DOPO AVER ESEGUITO LO SCAVO GETTARE SUL FONDO UNO STRATO DI CALCESTRUZZO DISTRIBUITO UNIFORMEMENTE ONDE EVITARE CEDIMENTI O ROTTURE DELLA FOSSA STESSA DOVUTO AL PESO.

POSARE NELLO SCAVO L' ANELLO CON IL FONDO APPONGIANDOLO SUL SUOLO IN PRECEDENZA LIVELLATO.

SI PROCEDE CON LA POSA DEGLI ANELLI DI PROLUNGA ,IN BASE ALLE ESIGENZE,

FACENDO ATTENZIONE A SIGILLARLI PERFETTAMENTE FRA DI LORO CON CEMENTO PLASTICO.

PROSEGUIRE CON LA POSA DELL' ANELLO FORNITO DI DIAFRAMMA E DI IMBOCCO DI ENTRATA E DI USCITA'

PER L' INNESTO DEI TUBI,DA NON INVERTIRE,CONSIDERANDO CHE L' ENTRATA E' SITUATA PIU' IN ALTO DELL' USCITA .

COPRIRE LA FOSSA CON L' APPOSITO COPERCHIO FORNITO DI PIU' ISPEZIONI PER LA PULIZIA DELLA STESSA.

FUNZIONAMENTO

L' ACQUA PROVVENIENTE DAGLI SCARICHI AFFLUISCE,ATTRAVERSO L' IMBOCCO DI ENTRATA ,

NELLA VASCA DI SEDIMENTAZIONE SITUATA NELLA PARTE SUPERIORE DELLA FOSSA.

DA QUI IL MATERIALE PESANTE SI DEPOSITA SUL FONDO ,NELLA VASCA DI DIGESTIONE.

CONCLSO IL PROCESSO DI CHIARIFICAZIONE L' ACQUA SALE ED ESCE ATTRAVERSO IL FORO DI USCITA.

MANUTENZIONE

LE VASCHE IMHOFF RICHIEDONO L' ISPEZIONE E L'ELIMINAZIONE PERIODICA DELLE

SOSTANZE LEGGERE GALLEGGIANTI, RACCOLTE NELLA PARTE ALTA DEL COMPARTO DI SEDIMENTAZIONE ,

UNA ESTRAZIONE PERIODICA ,EFFETTUATA DA DITTE SPECIALIZZATE ,DEL FANGO DIGERITO IL QUALE

NON DEVE ESSERE ESPORTATO TUTTO MA SE NE DEVE LASCIARE UNA PICCOLA QUANTITA' IN MODO CHE I

MICROORGANISMI PRESENTI IN ESSO ,POSSANO ATTIVARE IMMEDIATAMENTE UN NUOVO PROCESSO DI DIGESTIONE.

DOPO L' OPERAZIONE DI PULIZIA SI DEVE RIEMPIRE LA VASCA CON ACQUA PULITA FINO ALLA QUOTA

DEL TUBO DI SCARICO.

FOSSA BIOLOGICA MONOLITICA - CHIARIFICATRICE - DECANTAZIONE

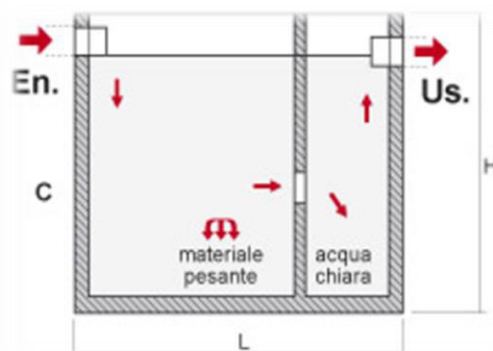
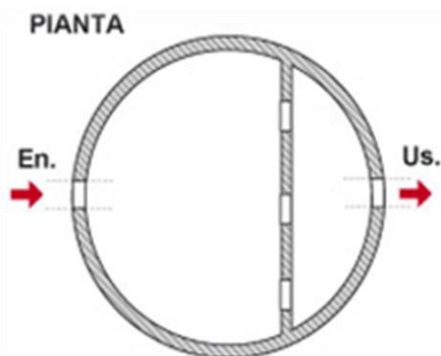

CODICE	PRODOTTO	DIMENSIONI DIAMETRO INTERNO*H	PESO CAD.	NUMERO PERSONE CONSIGLIATE	LITRI	LISTINO € / PEZZO
MONOLITICA60	FOSSA BIOLOGICA MONOLITICA	DIAM. 60 H 75	300	2 - 3	120	€ 53,50
MONOLITICA80	FOSSA BIOLOGICA MONOLITICA	DIAM. 80 H 80	500	5 - 7	450	€ 92,40
MONOLITICA100	FOSSA BIOLOGICA MONOLITICA	DIAM. 100 H 100	800	8 - 10	630	€ 186,00

*** LE SOLETTE SONO A PAG.46**

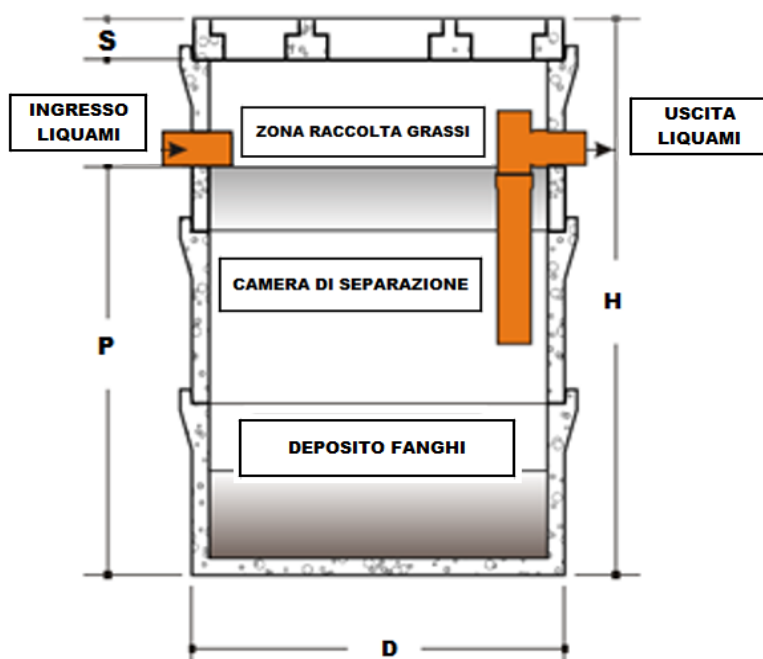

COND150	FOSSA BIOLOGICA	DIAM. 150 H 150	1600	20 - 30	2200	€ 320,00
COND200	FOSSA BIOLOGICA	DIAM. 200 H 200	3030	30 - 50	5500	€ 850,00

GRADINI CEMENTO - LASTRE INDUSTRIALI - PALI DA VIGNA



CODICE	PRODOTTO	DIMENSIONI B*L	PESO CAD.	PESO PALLET	PEZZI PALLET
SCALINO80	SCALINI DA 80 CM	80-36 H 4,5	33	330	10
SCALINO90	SCALINI DA 90 CM	90-36 H 4,5	37	370	10
SCALINO100	SCALINI DA 100 CM	100-36 H 4,5	41	410	10
SCALINO110	SCALINI DA 110 CM	110-36 H 4,5	45	450	10
SCALINO120	SCALINI DA 120 CM	120-36 H 4,5	49	490	10
SCALINO130	SCALINI DA 130 CM	130-36 H 4,5	54	540	10
SCALINO140	SCALINI DA 140 CM	140-36 H 4,5	60	600	10

LISTINO € / PEZZO

€ 21,00	SF
€ 23,00	SF
€ 25,00	SF
€ 27,00	SF
€ 29,00	SF
€ 32,00	SF
€ 34,00	SF

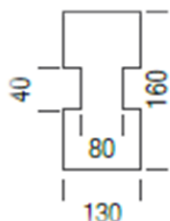

DIMENSIONE PALO



CLASTRE	LASTRA INDUSTRIALE	200-4 H 50	60	1200	20
CPAL180	PALO PER LASTRA 180 CM	16-13 H 180	90	-	1
CPAL240	PALO PER LASTRA 240 CM	16-13 H 240	115	-	1
CPAL290	PALO PER LASTRA 290 CM	16-13 H 290	135	-	1

€ 34,50	SF
€ 38,50	
€ 46,00	
€ 54,00	



VIGNA200	PALO IN CLS VIBRATO FORO DIAM.1,5 INTERASSE 12 CM	6 - 6.5 H 200	17	1190	70
VIGNA235	PALO IN CLS VIBRATO FORO DIAM.1,5 INTERASSE 12 CM	6 - 6.5 H 233	19	1330	70
VIGNA250	PALO IN CLS VIBRATO FORO DIAM. CM 1,5 INTERASSE CM 12	6 - 6.5 H 248	20	1400	70
VIGNA275	PALO IN CLS VIBRATO FORO DIAM. CM 1,5 INTERASSE CM 12	6 - 6.5 H 273	23	1610	70
VIGNA300	PALO IN CLS VIBRATO FORO DIAM.1,5 INTERASSE 12 CM	6 - 6.5 H 298	25	1750	70

€ 8,30	SF
€ 8,80	SF
€ 9,10	SF
€ 10,00	SF
€ 11,00	SF

CODICE	PRODOTTO	DIMENSIONI B*L*H	PESO CAD.	PESO PALLET	PEZZI PALLET
--------	----------	---------------------	--------------	----------------	-----------------

LISTINO € / PEZZO

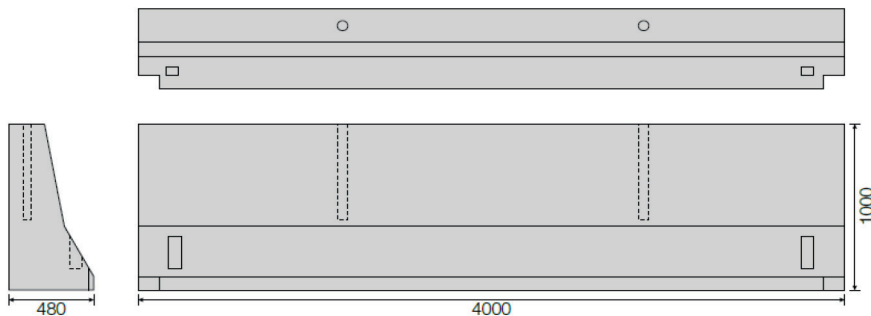

NY40	NEW JERSEY MONOPIEDE	48-400 H 100	2400	-	1
-------------	---------------------------------	-------------------------	-------------	----------	----------

€ 740,00

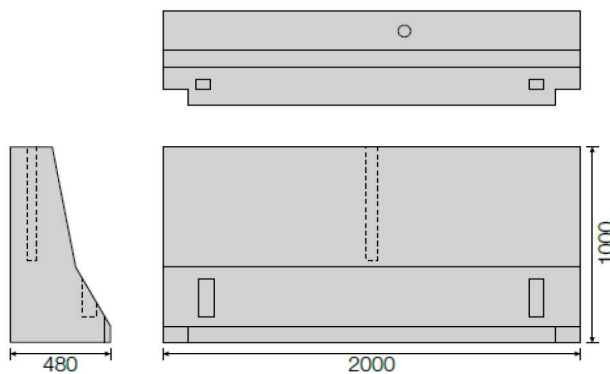

NY40R	NEW JERSEY MONOPIEDE	48-200 H 100	1200	2400	2
--------------	---------------------------------	-------------------------	-------------	-------------	----------

€ 375,00

SF

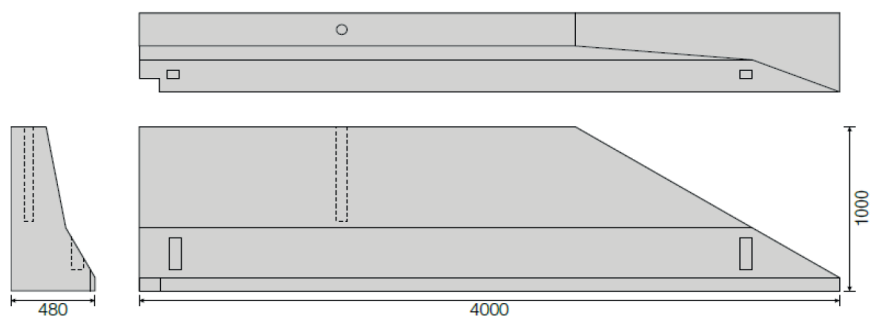

NY40DX	TERMINALE DESTRO	48-400 H 100	2000	-	1
---------------	-----------------------------	-------------------------	-------------	----------	----------

€ 740,00

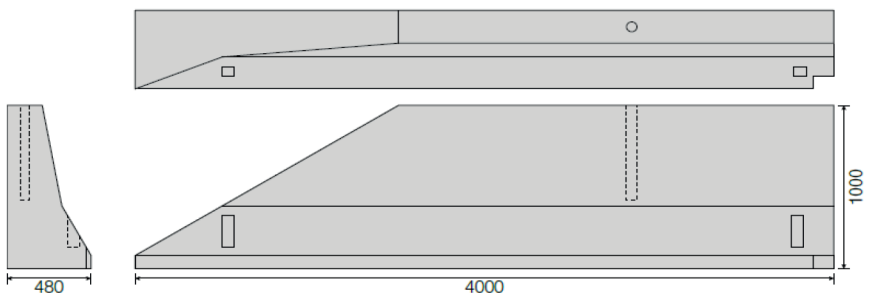

NY40SX	TERMINALE SINISTRO	48-400 H 100	2000	-	1
---------------	-------------------------------	-------------------------	-------------	----------	----------

€ 740,00

CODICE	PRODOTTO	DIMENSIONI B*L*H	PESO CAD.	PESO PALLET	PEZZI PALLET
--------	----------	---------------------	--------------	----------------	-----------------

LISTINO € / PEZZO

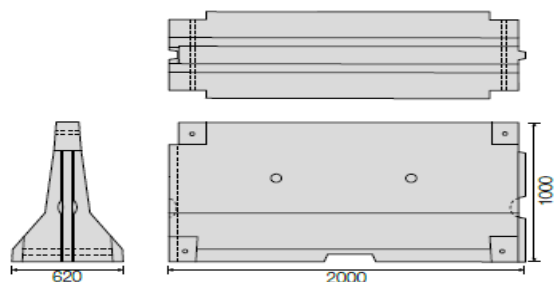

NYB20	NEW JERSEY BIPIEDE	62-200 H 100	1400	2800	2
-------	-----------------------	-----------------	------	------	---

€ 390,00 SF

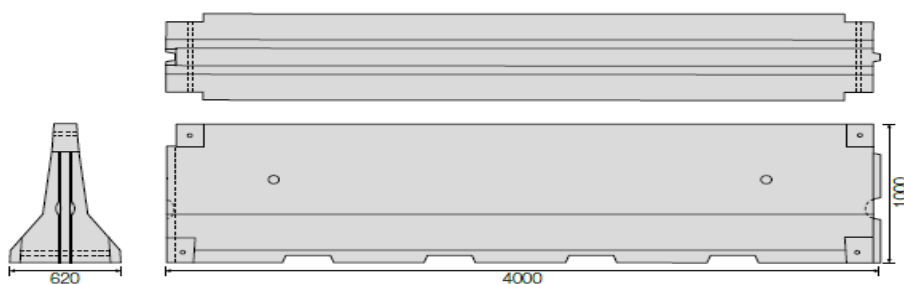

NYB40	NEW JERSEY BIPIEDE	62-400 H 100	2800	-	1
-------	-----------------------	-----------------	------	---	---

€ 780,00

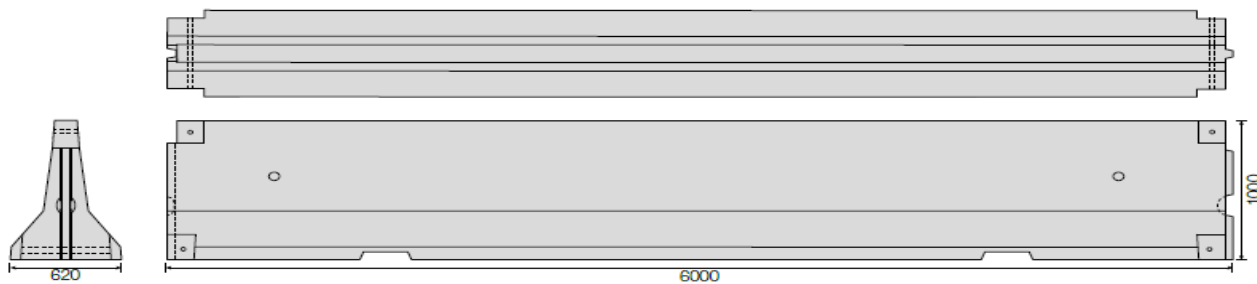

NYB60	NEW JERSEY BIPIEDE	62-600 H 100	4200	-	1
-------	-----------------------	-----------------	------	---	---

€ 1.170,00

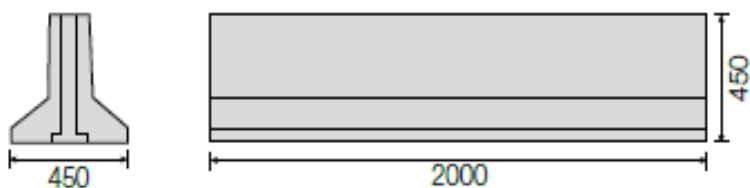

NYM20	NEW JERSEY MINI	45-200 H 45	450	2700	6
-------	-----------------	----------------	-----	------	---

€ 103,00 SF



**ATTENZIONE
DA VERIFICARE SEMPRE :**

**L' ALTEZZA DEL PALO ,FUORI TERRA
LA LUNGHEZZA DELLO SBRACCIO DEL PALO
LA REGIONE IN CUI VIENE POSATO**

SI CONSIGLIA DI TELEFONARE IN SEDE ,PER CONCORDARE IL GIUSTO DIMENSIONAMENTO

CODICE	PRODOTTO DIMENSIONI B*L*H	ALLOGGIO COPERCHIO	POZZETTO INTERNO	DIAM. FORO	PESO CAD.	LISTINO € / PEZZO
CPLINTO40	PLINTO ILLUMINAZIONE 75 - 40 H 65	40 X 40	30 X 30	20 CM CONICO	280	€ 98,00
CTP30PLINTO	COPERCHIO LEGGERO	40-40 H 3,5	-	-	15	€ 12,00
CPLINTO80	PLINTO ILLUMINAZIONE 80 - 60 H 70	40 X 40	30 X 30	22 CM CONICO	550	€ 117,00
CTP30PLINTO	COPERCHIO LEGGERO	40-40 H 3,5	-	-	15	€ 12,00
CPLINTO100	PLINTO ILLUMINAZIONE 100 - 60 H 80	52 X 52	40 X 40	27 CM CONICO	810	€ 142,00
CTP40	COPERCHIO LEGGERO	50-50 H 4	-	-	15	€ 7,30
CPLINTO110	PLINTO ILLUMINAZIONE 110 - 70 H 80	51 X 51	40 X 40	28 CM CONICO	1000	€ 164,00
CTP40	COPERCHIO LEGGERO	50-50 H 4	-	-	15	€ 7,30
CPLINTO120	PLINTO ILLUMINAZIONE 120 - 110 H 100	61 X 61	50 X 50	30 CM CONICO	2500	€ 320,00
CTP50	COPERCHIO LEGGERO	60-60 H 4.5	-	-	32	€ 10,40

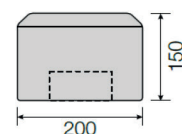
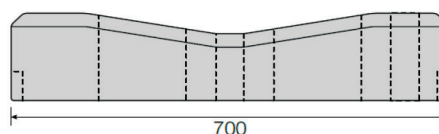
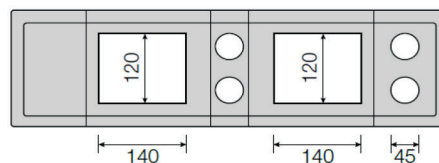

CPLINTINO	PLINTINO PER RETI DA CANTIERE	20-70 H 15	32	1536	48	€ 6,30 SF
-----------	----------------------------------	---------------	----	------	----	------------------



CODICE	PRODOTTO	DIMENSIONI INTERNE INT. B*L*H	PESO CAD.	PESO PALLET	PEZZI PALLET
---------------	-----------------	--	----------------------	------------------------	-------------------------

LISTINO € / PEZZO

CPO60TELECOM	POZZETTO	60-60 H 100	830	-	1
CPO120TELECOM	POZZETTO	120-60 H 100	1280	-	1

€ 190,00
€ 240,00

CPR60100TELECOM	PROLUNGHE	60-60 H 100	750	-	1
CPR12020TELECOM	PROLUNGHE	120-60 H 20	240	-	1
CPR120100TELECOM	PROLUNGHE	120-60 H 100	1100	-	1

€ 190,00
€ 87,00
€ 240,00

CODICE	PRODOTTO	DIMENSIONI EST. B*L*H	PESO CAD.	FORO DIAM.	NOTE
--------	----------	--------------------------	--------------	---------------	------

LISTINO € / PEZZO



POZZETTO IRRIGAZIONE 2 FORI

CON SERRAGGIO

* SU ORDINAZIONE E' POSSIBILE AVERLO CON 2 SERRAGGI

CPO721102	POZZETTO IRRIGAZIONE 2 FORI	72 X 72 H 110	390	50 CM	X TUBO 40 E 50	€ 121,00
CPO721202	POZZETTO IRRIGAZIONE 2 FORI	72 X 72 H 120	420	50 CM	X TUBO 40 E 50	€ 121,00
CPO851002	POZZETTO IRRIGAZIONE 2 FORI	85 X 85 H 100	460	60 CM	X TUBO 50 E 60	€ 133,00
CPO851202	POZZETTO IRRIGAZIONE 2 FORI	85 X 85 H 120	500	60 CM	X TUBO 50 E 60	€ 133,00
CPO851402	POZZETTO IRRIGAZIONE 2 FORI	85 X 85 H 140	540	60 CM	X TUBO 50 E 60	€ 133,00
CPO1201202	POZZETTO IRRIGAZIONE 2 FORI	120 X 120 H 120	800	80 CM	X TUBO 80	€ 218,00
CPO1401402	POZZETTO IRRIGAZIONE 2 FORI	140 X 140 H 140	1300	100 CM	X TUBO 100	€ 315,00



POZZETTO IRRIGAZIONE 3 FORI

CON SERRAGGIO

CPO721103	POZZETTO IRRIGAZIONE 3 FORI	72 X 72 H 110	350	50 CM	X TUBO 40 E 50	€ 121,00
CPO721203	POZZETTO IRRIGAZIONE 3 FORI	72 X 72 H 120	380	50 CM	X TUBO 40 E 50	€ 121,00
CPO851003	POZZETTO IRRIGAZIONE 3 FORI	85 X 85 H 100	420	60 CM	X TUBO 50 E 60	€ 133,00
CPO851203	POZZETTO IRRIGAZIONE 3 FORI	85 X 85 H 120	460	60 CM	X TUBO 50 E 60	€ 133,00
CPO851403	POZZETTO IRRIGAZIONE 3 FORI	85 X 85 H 140	500	60 CM	X TUBO 50 E 60	€ 133,00
CPO1201203	POZZETTO IRRIGAZIONE 3 FORI	120 X 120 H 120	750	80 CM	X TUBO 80	€ 218,00
CPO1401403	POZZETTO IRRIGAZIONE 3 FORI	140 X 140 H 140	1200	100 CM	X TUBO 100	€ 315,00

CODICE	PRODOTTO	DIMENSIONI EST. B*L*H	PESO CAD.	FORO DIAM.	NOTE
--------	----------	--------------------------	--------------	---------------	------

LISTINO € / PEZZO



POZZETTO IRRIGAZIONE 2 FORI

SENZA SERRAGGIO

CPO721102C	POZZETTO IRRIGAZIONE 2 FORI	72 X 72 H 110	420	50 CM	X TUBO 40 E 50	€ 121,00
CPO721202C	POZZETTO IRRIGAZIONE 2 FORI	72 X 72 H 120	450	50 CM	X TUBO 40 E 50	€ 121,00
CPO851002C	POZZETTO IRRIGAZIONE 2 FORI	85 X 85 H 100	500	60 CM	X TUBO 50 E 60	€ 133,00
CPO851202C	POZZETTO IRRIGAZIONE 2 FORI	85 X 85 H 120	540	60 CM	X TUBO 50 E 60	€ 133,00
CPO851402C	POZZETTO IRRIGAZIONE 2 FORI	85 X 85 H 140	580	60 CM	X TUBO 50 E 60	€ 133,00
CPO1201202C	POZZETTO IRRIGAZIONE 2 FORI	120 X 120 H 120	850	80 CM	X TUBO 80	€ 218,00
CPO1401402C	POZZETTO IRRIGAZIONE 2 FORI	140 X 140 H 140	1400	100 CM	X TUBO 100	€ 315,00



POZZETTO IRRIGAZIONE 3 FORI

SENZA SERRAGGIO

CPO721103C	POZZETTO IRRIGAZIONE 3 FORI	72 X 72 H 110	390	50 CM	X TUBO 40 E 50	€ 121,00
CPO721203C	POZZETTO IRRIGAZIONE 3 FORI	72 X 72 H 120	420	50 CM	X TUBO 40 E 50	€ 121,00
CPO851003C	POZZETTO IRRIGAZIONE 3 FORI	85 X 85 H 100	460	60 CM	X TUBO 50 E 60	€ 133,00
CPO851203C	POZZETTO IRRIGAZIONE 3 FORI	85 X 85 H 120	500	60 CM	X TUBO 50 E 60	€ 133,00
CPO851403C	POZZETTO IRRIGAZIONE 3 FORI	85 X 85 H 140	540	60 CM	X TUBO 50 E 60	€ 133,00
CPO1201203C	POZZETTO IRRIGAZIONE 3 FORI	120 X 120 H 120	800	80 CM	X TUBO 80	€ 218,00
CPO1401403C	POZZETTO IRRIGAZIONE 3 FORI	140 X 140 H 140	1300	100 CM	X TUBO 100	€ 315,00



CODICE	PRODOTTO	DIMENSIONI INTERNE B*L*H	PESO CAD.	PESO PALLET	PEZZI PALLET
--------	----------	--------------------------------	--------------	----------------	-----------------

LISTINO € / PEZZO

CPO20	POZZETTO	20-20 H 25	20	600	30
CPO25	POZZETTO	25-25 H 25	26	700	27
CPO30	POZZETTO	30-30 H 30	46	830	18
CPO40	POZZETTO	40-40 H 40	90	-	1
CPO50	POZZETTO	50-50 H 50	160	-	1
CPO60	POZZETTO	60-60 H 60	245	-	1
CPO70	POZZETTO	70-70 H 70	450	-	1
CPO80	POZZETTO	80-80 H 80	640	-	1
CPO100	POZZETTO	100-100 H 100	1210	-	1
CPO120	POZZETTO	120-120 H 100	1670	-	1
CPO150100	POZZETTO	150-150 H 100	2300	-	1
CPO200	POZZETTO	200-200 H 80	3500	-	1

€	6,00	SF
€	6,00	SF
€	6,80	SF
€	9,30	
€	16,60	
€	25,20	
€	56,00	
€	76,00	
€	108,50	
€	200,00	
€	500,00	
€	825,00	



CODICE	PRODOTTO	DIMENSIONI INTERNE B*L*H	PESO CAD.	PESO PALLET	PEZZI PALLET
--------	----------	--------------------------------	--------------	----------------	-----------------

LISTINO € / PEZZO

CPR20	PROLUNGHE	20-20 H 25	16	480	30
CPR25	PROLUNGHE	25-25 H 25	22	530	24
CPR30	PROLUNGHE	30-30 H 30	37	670	18
CPR40	PROLUNGHE	40-40 H 40	80	-	1
CPR50	PROLUNGHE	50-50 H 50	126	-	1
CPR60	PROLUNGHE	60-60 H 60	205	-	1
CPR70	PROLUNGHE	70-70 H 70	350	-	1
CPR80	PROLUNGHE	80-80 H 80	535	-	1
CPR100	PROLUNGHE	100-100 H 100	1030	-	1
CPR120	PROLUNGHE	120-120 H 100	1335	-	1
CPR150100	PROLUNGHE	150-150 H 100	1800	-	1
CPR200	PROLUNGHE	200-200 H 80	2150	-	1

€	6,00	SF
€	6,00	SF
€	6,80	SF
€	9,30	
€	16,60	
€	25,20	
€	53,00	
€	69,00	
€	103,00	
€	173,00	
€	382,00	
€	691,00	



CODICE	PRODOTTO	DIMENSIONI INTERNE B*L*H	PESO CAD.	PESO PALLET	PEZZI PALLET
--------	----------	--------------------------------	--------------	----------------	-----------------

LISTINO € / PEZZO

POZZETTI "SLIM "

CPO80L	POZZETTO "SLIM"	80-80 H 76	440	-	1
CPO100L	POZZETTO "SLIM"	100-100 H 100	815	-	1

€ 47,00
€ 78,00

PROLUNGHE "SLIM "

CPR80L	PROLUNGA "SLIM"	80-80 H 76	340	-	1
CPR100L	PROLUNGA "SLIM"	100-100 H 100	615	-	1

€ 46,00
€ 75,00

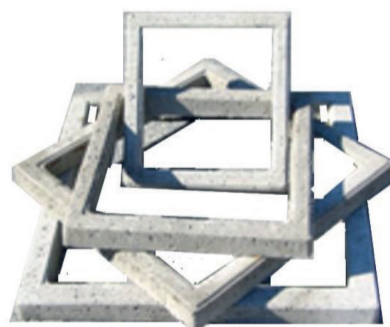

CODICE	PRODOTTO	DIMENSIONI INTERNE B*L*H	PESO CAD.	PESO PALLET	PEZZI PALLET
--------	----------	-----------------------------	-----------	-------------	--------------

LISTINO € / PEZZO

ALTEZZA 5 CM

CPR3005	PROLUNGHE	30-30 H 5	5	50	10
CPR4005	PROLUNGHE	40-40 H 5	7	70	10
CPR5005	PROLUNGHE	50-50 H 5	10	100	10
CPR6005	PROLUNGHE	60-60 H 5	16	160	10

€	6,40	SF
€	7,90	SF
€	9,70	SF
€	12,40	SF

ALTEZZA 10 CM

CPR3010	PROLUNGHE	30-30 H 10	11	110	10
CPR4010	PROLUNGHE	40-40 H 10	18	180	10
CPR5010	PROLUNGHE	50-50 H 10	26	260	10
CPR6010	PROLUNGHE	60-60 H 10	36	360	10

€	6,70	SF
€	9,20	SF
€	12,50	SF
€	15,50	SF

ALTEZZA 20 CM

CPR3020	PROLUNGHE	30-30 H 20	25	150	6
CPR4020	PROLUNGHE	40-40 H 20	40	240	6
CPR5020	PROLUNGHE	50-50 H 20	50	300	6
CPR6020	PROLUNGHE	60-60 H 20	60	360	6
CPR7020	PROLUNGHE	70-70 H 20	70	420	6
CPR8020	PROLUNGHE	80-80 H 20	110	660	6

€	8,50	SF
€	11,00	SF
€	15,00	SF
€	16,30	SF
€	31,00	SF
€	31,00	SF

ALTEZZA 25 CM

CPR10025	PROLUNGHE	100-100 H 25	250	-	1
CPR12025	PROLUNGHE	120-120 H 25	300	-	1
CPR15025	PROLUNGHE	150-150 H 25	650	-	1

€	54,50
€	67,00
€	161,00

ALTEZZA 40 CM

CPR8040	PROLUNGHE	80-80 H 40	230	-	1
---------	-----------	------------	-----	---	---

€	46,00
---	-------

ALTEZZA 50 CM

CPR10050	PROLUNGHE	100-100 H 50	430	-	1
CPR12050	PROLUNGHE	120-120 H 50	650	-	1
CPR15050	PROLUNGHE	150-150 H 50	1300	-	1
CPR20050	PROLUNGHE	200-200 H 50	1650	-	1

€	65,00
€	94,00
€	233,00
€	645,00

SOLETTE CIRCOLARI PER FOSSA

CODICE	PRODOTTO	DIMENSIONI DIAM.* H	PESO CAD.	NUMERO FORI PER ISPEZIONE	CLASSE PORTATA	LISTINO € / PEZZO
--------	----------	------------------------	--------------	------------------------------	-------------------	----------------------

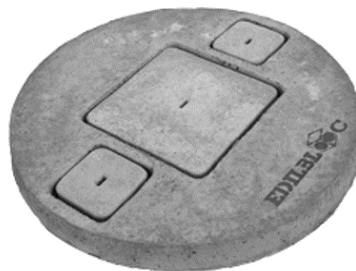
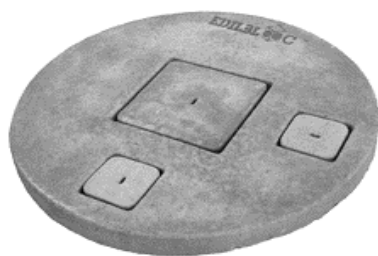

SOLETTE CIRCOLARI PEDONALI PER FOSSA

CCP60F	SOLETTA PEDONALE PER FOSSA DIAM. 60	DIAM.68 H 8	60	1 ISPEZIONE CENTRALE 26x26 cm.	A15	€ 16,60
CCP80F	SOLETTA PEDONALE PER FOSSA DIAM. 80	DIAM.85 H 9	80	3 ISPEZIONI: 1 CENTRALE 32x32 cm. 2 LATERALI 13x13 cm.	A15	€ 38,40
CCP100F	SOLETTA PEDONALE PER FOSSA DIAM. 100	DIAM.109 H 8	150	3 ISPEZIONI: 1 CENTRALE 33x33 cm. 2 LATERALI 14x14 cm.	A15	€ 55,50
CCP120F	SOLETTA PEDONALE PER FOSSA DIAM. 120	DIAM.133 H 9,5	300	3 ISPEZIONI: 1 CENTRALE 40x40 cm. 1 LATERALE 20x20 cm. 1 LATERALE 12X12 cm.	A15	€ 75,50
CCP150F	SOLETTA PEDONALE PER FOSSA DIAM. 150	DIAM.162 H 10	460	3 ISPEZIONI: 1 CENTRALE 40x40 cm. 2 LATERALE 25x25 cm.	A15	€ 153,50

SOLETTE CIRCOLARI CARRABILI PER FOSSA

CCC60F	SOLETTA CARRABILE PER FOSSA DIAM. 60	DIAM.70 H 11	100	1 ISPEZIONE CENTRALE 33x33 cm.	C250 TAPPO ESCLUSO	€ 37,00
CCC80F	SOLETTA CARRABILE PER FOSSA DIAM. 80	DIAM.90 H 15	200	1 ISPEZIONE CENTRALE 45x45 cm.	C250 TAPPO ESCLUSO	€ 62,00
CCC100F	SOLETTA CARRABILE PER FOSSA DIAM. 100	DIAM.116 H 15	400	3 ISPEZIONI: 1 CENTRALE 45x45 cm. 2 LATERALI 17x17 cm.	C250 TAPPO ESCLUSO	€ 121,00
CCC120T	SOLETTA CIRCOLARE PER TUBO DIAM. 120	DIAM.133 H 15	500	1 ISPEZIONE CENTRALE 45x45 cm.	C250 TAPPO ESCLUSO	€ 145,00
CCC150F	SOLETTA CARRABILE PER FOSSA DIAM. 150	DIAM. 165 H 20	750	4 ISPEZIONI: 1 CENTRALE 45x45 cm. 3 LATERALI 15x15 cm.	C250 TAPPO ESCLUSO	€ 295,00
CCC200F	SOLETTA CARRABILE PER FOSSA DIAM. 200	DIAM. 216 H 20	1600	4 ISPEZIONI: 1 CENTRALE 55x55 cm. 3 LATERALI 24x24 cm.	C250 TAPPO ESCLUSO	€ 510,00



SOLETTA CIRCOLARE CARRABILE CON FORO DIAM.60

CCC100FORO	SOLETTA CIRCOLARE FORO (1° CAT.) LATERALE	DIAM.120 H 20	400	FORO DIAM. 60	D400	€ 121,00
CCC150FORO	SOLETTA CIRCOLARE FORO (1° CAT.) CENTRALE	DIAM.160 H 20	700	FORO DIAM. 60	D400	€ 326,00
CCC200FORO	SOLETTA CIRCOLARE FORO (1° CAT.) LATERALE	DIAM.216 H 20	1750	FORO DIAM. 60	D400	€ 650,00

CODICE	PRODOTTO	DIMENSIONI DIAM. * H	PESO CAD.	NUMERO FORI PER ISPEZIONE	CLASSE PORTATA	LISTINO € / PEZZO
--------	----------	-------------------------	--------------	------------------------------	-------------------	----------------------

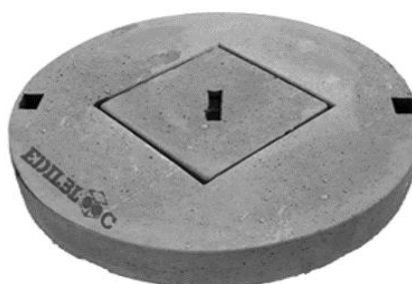
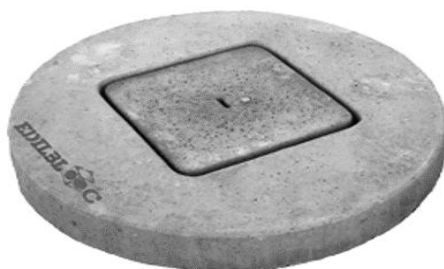

SOLETTE CIRCOLARI PEDONALI PER TUBO

CCP60T	SOLETTA PEDONALE PER TUBO DIAM. 60	DIAM.67 H 9	60	1 ISPEZIONE CENTRALE 26x26 cm.	A15	€ 16,60
CCP80T	SOLETTA PEDONALE PER TUBO DIAM. 80	DIAM.85 H 9	80	1 ISPEZIONE CENTRALE 33x33 cm.	A15	€ 38,40
CCP100T	SOLETTA PEDONALE PER TUBO DIAM. 100	DIAM.114 H 8	150	1 ISPEZIONE CENTRALE 45x45 cm.	A15	€ 55,50
CCP120F	SOLETTA PEDONALE PER FOSSA DIAM. 120	DIAM.133 H 9,5	300	3 ISPEZIONI: 1 CENTRALE 40x40 cm. 1 LATERALE 20x20 cm. 1 LATERALE 12x12 cm.	A15	€ 75,50
CCP150F	SOLETTA PEDONALE PER FOSSA DIAM. 150	DIAM.162 H 10	460	3 ISPEZIONI: 1 CENTRALE 40x40 cm. 2 LATERALE 25x25 cm.	A15	€ 153,50

SOLETTE CIRCOLARI CARRABILI PER TUBO

CCC60T	SOLETTA CIRCOLARE PER TUBO DIAM. 60	DIAM.70 H 12	100	1 ISPEZIONE CENTRALE 33x33 cm.	C250 TAPPO ESCLUSO	€ 37,00
CCC80T	SOLETTA CIRCOLARE PER TUBO DIAM. 80	DIAM.90 H 15	200	1 ISPEZIONE CENTRALE 45x45 cm.	C250 TAPPO ESCLUSO	€ 62,00
CCC100T	SOLETTA CIRCOLARE PER TUBO DIAM. 100	DIAM.116 H 15	400	1 ISPEZIONE CENTRALE 45x45 cm.	C250 TAPPO ESCLUSO	€ 121,00
CCC120T	SOLETTA CIRCOLARE PER TUBO DIAM. 120	DIAM.133 H 15	500	1 ISPEZIONE CENTRALE 45x45 cm.	C250 TAPPO ESCLUSO	€ 145,00
CCC150F	SOLETTA CARRABILE PER FOSSA DIAM. 150	DIAM. 165 H 20	750	4 ISPEZIONI: 1 CENTRALE 45x45 cm. 3 LATERALI 15x15 cm.	C250 TAPPO ESCLUSO	€ 295,00
CCC200T	SOLETTA CIRCOLARE PER TUBO DIAM. 200	DIAM. 216 H 20	1600	1 ISPEZIONE CENTRALE 55x55 cm.	C250 TAPPO ESCLUSO	€ 510,00



SOLETTA CIRCOLARE CARRABILE CON FORO DIAM.60

CCC100FORO	SOLETTA CIRCOLARE FORO (1° CAT.) LATERALE	DIAM.120 H 20	400	FORO DIAM. 60	D400	€ 121,00
CCC150FORO	SOLETTA CIRCOLARE FORO (1° CAT.) CENTRALE	DIAM.160 H 20	700	FORO DIAM. 60	D400	€ 326,00
CCC200FORO	SOLETTA CIRCOLARE FORO (1° CAT.) LATERALE	DIAM.216 H 20	1750	FORO DIAM. 60	D400	€ 650,00



ABBIAMO ANCHE LA
RELAZIONE DI CALCOLO PER
USARLE COME BASE DI
APPOGGIO PER LE GRU DA
CANTIERE

CODICE	PRODOTTO	DIMENSIONI B*L*H	PESO CAD.	PESO PALLET	PEZZI PALLET	CLASSE PORTATA	LISTINO € / PEZZO
CSOL100PIENA	SOLETTA PIENA PER POZZETTO 80	95-95 H 20	425	-	1	D 400	€ 120,00
CSOL120PIENA	SOLETTA PIENA PER POZZETTO 100	120-120 H 20	700	-	1	D 400	€ 132,00
CSOL140PIENA	SOLETTA PIENA PER POZZETTO 120	140-140 H 20	1000	-	1	D 400	€ 257,00
CSOL180PIENA	SOLETTA PIENA PER POZZETTO 150	180-180 H 20	1650	-	1	D 400	€ 400,00

SOLETTE SU MISURA

SU ORDINAZIONE SI PRODUCONO SOLETTE DI QUALSIASI MISURA H 20 CM

ATTENZIONE : IL PREZZO SI INTENDE PER METRO QUADRO

200 / MQ

SOLETTE CARRABILI PER POZZETTI

CODICE	PRODOTTO	DIMENSIONI B*L*H	PESO CAD.	PESO PALLET	PEZZI PALLET	CLASSE PORTATA	LISTINO € / PEZZO
--------	----------	---------------------	--------------	----------------	-----------------	-------------------	----------------------

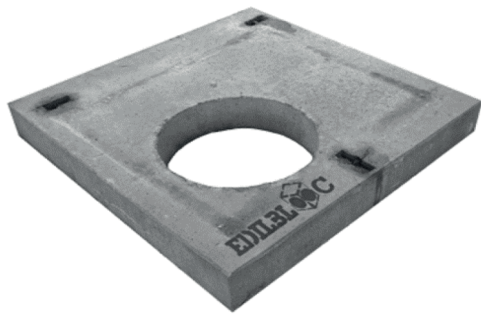

FORO LATERALE: DIAM. 60 CM

CSOL100	SOLETTA PER POZZETTO 80	95-95 H 20	300	1500	5	D 400	€ 87,50	SF
CSOL120	SOLETTA PER POZZETTO 100	120-120 H 20	540	1620	3	D 400	€ 99,00	SF
CSOL140	SOLETTA PER POZZETTO 120	140-140 H 20	840	-	1	D 400	€ 181,50	
CSOL180	SOLETTA PER POZZETTO 150	180-180 H 20	1500	-	1	D 400	€ 333,00	
CSOL230	SOLETTA PER POZZETTO 200	230-230 H 20	2200	-	1	D 400	€ 1.010,00	

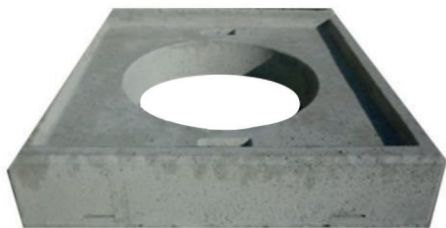

FORO CENTRALE : DIAMETRO 60 CM

RIBASSO : 90 X 90 H 4 CM

CSOL100R	SOLETTA PER POZZETTO 80	95-95 H 20	300	1500	5	D 400	€ 87,50	SF
CSOL120R	SOLETTA PER POZZETTO 100	120-120 H 20	540	1620	3	D 400	€ 99,00	SF

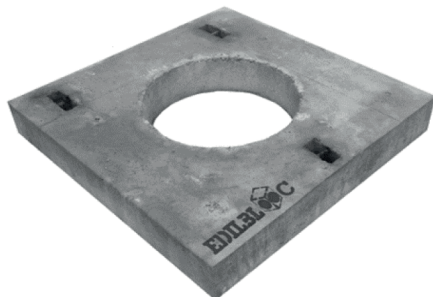

FORO CENTRALE: DIAMETRO 60 CM

CSOL120C	SOLETTA PER POZZETTO 100	120-120 H 20	540	1620	3	D 400	€ 99,00	SF
CSOL140C	SOLETTA PER POZZETTO 120	140-140 H 20	840	-	1	D 400	€ 181,50	
CSOL180C	SOLETTA PER POZZETTO 150	180-180 H 20	1500	-	1	D 400	€ 316,00	

SOLETTE SU MISURA

**SU ORDINAZIONE SI PRODUCONO SOLETTE DI QUALSIASI MISURA H 20 CM
ATTENZIONE : IL PREZZO SI INTENDE PER METRO QUADRO**

200,00 € / MQ



**CISTERNE CIRCOLARI IN
CALCESTRUZZO , CON INCASTRO
A BICCHIERE PER FACILITARE LA
TENUTA TRA GLI ELEMENTI**

**PER UNA BUONA TENUTA E'
CONSIGLIABILE RASARE E SIGILLARE
GLI ELEMENTI CON MALTE APPOSITE**

CODICE	PRODOTTO DIMENSIONI INTERNE	ALTEZZA	DIM. MAX ESTERNE	PESO	CAPACITA' LITRI	LISTINO € / PEZZO
CIST100H80	CISTERNA DIAM. 100	H 78	DIAM.124	660	430	€ 110,00
CIST100H160	CISTERNA DIAM. 100	H 156	DIAM.124	1160	1050	€ 220,00
CIST100H240	CISTERNA DIAM. 100	H 234	DIAM.124	1660	1700	€ 330,00
CIST100H320	CISTERNA DIAM. 100	H 312	DIAM.124	2160	2300	€ 440,00
CIST100H400	CISTERNA DIAM. 100	H 390	DIAM.124	2660	2930	€ 550,00
CIST150H50	CISTERNA DIAM. 150	H 50	DIAM.174	600	440	€ 140,00
CIST150H100	CISTERNA DIAM. 150	H 100	DIAM.174	1100	1320	€ 230,00
CIST150H150	CISTERNA DIAM. 150	H 150	DIAM.174	1600	2200	€ 320,00
CIST150H200	CISTERNA DIAM. 150	H 200	DIAM.174	2100	3080	€ 410,00
CIST150H250	CISTERNA DIAM. 150	H 250	DIAM.174	2600	3960	€ 500,00
CIST150H300	CISTERNA DIAM. 150	H 300	DIAM.174	3100	4840	€ 590,00
CIST150H350	CISTERNA DIAM. 150	H 350	DIAM.174	3600	5720	€ 680,00
CIST150H400	CISTERNA DIAM. 150	H 400	DIAM.174	4100	6600	€ 770,00
CIST200H50	CISTERNA DIAM. 200	H 50	DIAM.224	1200	785	€ 250,00
CIST200H100	CISTERNA DIAM. 200	H 100	DIAM.224	1810	2350	€ 450,00
CIST200H150	CISTERNA DIAM. 200	H 150	DIAM.224	2420	3900	€ 650,00
CIST200H200	CISTERNA DIAM. 200	H 200	DIAM.224	3030	5500	€ 850,00
CIST200H250	CISTERNA DIAM. 200	H 250	DIAM.224	3640	7050	€ 1.050,00
CIST200H300	CISTERNA DIAM. 200	H 300	DIAM.224	4250	8600	€ 1.250,00
CIST200H350	CISTERNA DIAM. 200	H 350	DIAM.224	4860	10150	€ 1.450,00
CIST200H400	CISTERNA DIAM. 200	H 400	DIAM.224	5470	11700	€ 1.650,00



CODICE	PRODOTTO DIAMETRO INT.	SPESSORE PARETE	PESO CAD.	LUNGHEZZA UTILE	LISTINO € / PEZZO
CTBI20	TUBO CEMENTO DIAM. 20 CM	35 MM	53	100 CM	€ 12,80
CTBI30	TUBO CEMENTO DIAM. 30 CM	50 MM	80	100 CM	€ 15,40
CTBI40	TUBO CEMENTO DIAM. 40 CM	55 MM	130	100 CM	€ 20,60
CTBI50	TUBO CEMENTO DIAM. 50 CM	43 MM	180	100 CM	€ 26,20
CTBI60	TUBO CEMENTO DIAM. 60 CM	48 MM	240	100 CM	€ 32,00
CTBI80	TUBO CEMENTO DIAM. 80 CM	60 MM	370	100 CM	€ 53,00
CTBI100	TUBO CEMENTO DIAM. 100 CM	70 MM	550	100 CM	€ 75,60
CTBI125	TUBO CEMENTO DIAM. 125 CM	75 MM	1000	100 CM	€ 167,70
CTBI150	TUBO CEMENTO DIAM. 150 CM	80 MM	1200	100 CM	€ 265,00

TUBI FORATI - SEGNATI TIPO "CUNETTA"

CODICE	PRODOTTO DIAMETRO INT.	SPESSORE PARETE	PESO CAD.	LUNGHEZZA UTILE
--------	---------------------------	--------------------	--------------	--------------------

LISTINO € / PEZZO



CTBI80FOR	TUBO FORATO DIAMETRO 80 CM	60 MM	370	100 CM
CTBI100FOR	TUBO FORATO DIAMETRO 100 CM	70 MM	550	100 CM
CTBI125FOR	TUBO FORATO DIAMETRO 125 CM	75 MM	1000	100 CM
CTBI150FOR	TUBO FORATO DIAMETRO 150 CM	80 MM	1200	100 CM

€ 60,00
€ 84,50
€ 192,00
€ 300,00



**TUBO CON INCASTRO,
FORNITI INTERI,
PREINCISI IN SENSO
LONGITUDINALE
PER LA DIVISIONE.**

***ATTENZIONE LA FOTO ILLUSTRIL PRODOTTO FINITO**

***LUNGHEZZA UTILE 100 CM PER OGNI PEZZO**

CTBI30MEZ	TUBO INTERO DIAM. 30 SEGNATO	50 MM	80	PREZZO A TUBO INTERO DA DIVIDERE
CTBI40MEZ	TUBO INTERO DIAM. 40 SEGNATO	55 MM	130	PREZZO A TUBO INTERO DA DIVIDERE
CTBI50MEZ	TUBO INTERO DIAM. 50 SEGNATO	43 MM	180	PREZZO A TUBO INTERO DA DIVIDERE
CTBI60MEZ	TUBO INTERO DIAM. 60 SEGNATO	48 MM	240	PREZZO A TUBO INTERO DA DIVIDERE
CTBI80MEZ	TUBO INTERO DIAM. 80 SEGNATO	60 MM	370	PREZZO A TUBO INTERO DA DIVIDERE
CTBI100MEZ	TUBO INTERO DIAM.100 SEGNATO	70 MM	550	PREZZO A TUBO INTERO DA DIVIDERE

€ 17,40
€ 24,30
€ 30,70
€ 37,00
€ 61,00
€ 87,00

ANELLI PERDENTI - TENUTA - FONDO

CODICE	PRODOTTO	DIMENSIONI DIAM.INT.*H	PESO CAD.	PESO PALLET	PEZZI PALLET
--------	----------	---------------------------	--------------	----------------	-----------------

LISTINO € / PEZZO



CPERD80	ANELLO PERDENTE DIAM. 80 (SENZA INCASTRO BICCHIERE)	DIAM.80 H 50	140	560	4
CPERD100	ANELLO PERDENTE DIAM. 100 (SENZA INCASTRO BICCHIERE)	DIAM.100 H 50	175	700	4
CPERD150	ANELLO PERDENTE DIAM. 150	DIAM.150 H 50	500	2000	4
CPERD200	ANELLO PERDENTE DIAM. 200	DIAM.200 H 50	700	2800	4

€	51,00	SF
€	56,00	SF
€	90,00	SF
€	200,00	SF



CTEN80	ANELLO TENUTA DIAM. 80 (SENZA INCASTRO BICCHIERE)	DIAM.80 H 50	140	560	4
CTEN100	ANELLO TENUTA DIAM. 100 (SENZA INCASTRO BICCHIERE)	DIAM.100 H 50	175	700	4
CTEN150	ANELLO TENUTA DIAM. 150	DIAM.150 H 50	500	2000	4
CTEN200	ANELLO TENUTA DIAM. 200	DIAM.200 H 50	700	2800	4

€	51,00	SF
€	56,00	SF
€	90,00	SF
€	200,00	SF



VASCA80	VASCA CIRCOLARE DIAM. 80 (SENZA INCASTRO BICCHIERE)	DIAM.80 H 50	200	-	1
VASCA100	VASCA CIRCOLARE DIAM. 100 (SENZA INCASTRO BICCHIERE)	DIAM.100 H 50	280	-	1
VASCA150	VASCA CIRCOLARE DIAM.150	DIAM.150 H 50	650	-	1
VASCA200	VASCA CIRCOLARE DIAM.200	DIAM.200 H 50	1200	-	1

€	56,00
€	70,00
€	140,00
€	250,00

INDICE

<i>articolo</i>	<i>n.pag</i>
• AIUOLE TIPO VIMINI	15
• ANELLI CON FONDO	54
• ANELLI PERDENTI	54
• ANELLI TENUTA	54
• ARCHITRAVI IN LATERIZIO	3
• AUTOBLOCCANTI	5
• AUTOBLOCCANTI A PIASTRA	6
• BINDERO	13
• BLOCCHI CONTRORIVA	8
• BLOCCHI IN CEMENTO	4
• CHIUSINI	11
• COMIGNOLI IN CEMENTO	10
• COMPONENTE ESTERNO PER CAMINO IN ARGILLA	9
• COPERTINE	12
• COPRIDI IN GETTO 6/8 H 15/20/25	16
• CORDOLI IN CEMENTO VIBRATO	14
• CORDOLI IN GETTO	15
• CORDOLI IN GETTO OLANDESE - ANAS	25
• CORDOLI IN GETTO 10/12 H 25	18
• CORDOLI IN GETTO 10/12 H 25	19
• CORDOLI IN GETTO 12/15 H 25	20
• CORDOLI IN GETTO 12/15 H 25	21
• CORDOLI IN GETTO 12/15 H 25	22
• CORDOLI IN GETTO 12/15 H 30	23
• CORDOLI IN GETTO 8/10 H 25	17
• CORDOLI IN GETTO H 35/40/50	24
• CUNETTA ALLA FRANCESE	26
• CUNETTA ALL'ITALIANA	27
• CUNETTA PER SCARPATA	28
• DISSUASORI IN CEMENTO	30
• FOSSA CHIARIFICATRICE	35
• FOSSA DECANTAZIONE	35
• FOSSA IMHOF - POSA E MANUTENZIONE	34
• FOSSE CONDENSAGRASSI - DEGRASSATORI	31
• FOSSE DISOLEATRICI - DISSABBIATORE	31
• FOSSE IMHOF	33
• FOSSA BIOLOGICA MONOLITICA	35
• GRADINI CEMENTO	36
• LASTRE INDUSTRIALI	36
• MURAJA	7
• NEW JERSEY	38
• NEW JERSEY MONOPIEDE	37
• NORME PER FOSSE - CONDENSAGRASSI - DISOLEATORE	32
• PALI DA VIGNA	36
• PASSO CARRAIO	29
• PLINTI PORTAPALO	39
• POZZETTI IN CEMENTO	43
• POZZETTI IN CEMENTO "SLIM"	45
• POZZETTI IRRIGAZIONE	41
• POZZETTI IRRIGAZIONE	42
• POZZETTI TELECOM	40
• PROLUNGHE DI RACCORDO	46
• PROLUNGHE IN CEMENTO	44
• SERBATOIO DI ACCUMOLO	51
• SOLETTE CARRABILI PER POZZETTI	50
• SOLETTE CARRABILI PIENE	49
• SOLETTE CIRCOLARI PER FOSSA	47
• SOLETTE CIRCOLARI PER TUBO	48
• TAPPI LEGGERI	10
• TRASPORTI	2
• TUBI CEMENTO	52
• TUBI FORATI-SEGNATI TIPO "CUNETTA"	53

EDILBL  C



Via Gosi, 6 - 12083 Frabosa Sottana (CN)
Telefono 0174/243001 - Fax 0174/243900
Cell. 331-6224795
info@edilbloc.com - www.edilbloc.eu

 [@edilbloc](https://www.instagram.com/edilbloc)

 [@edilblocsnc](https://www.facebook.com/edilblocsnc)

 [@edilbloc](https://www.linkedin.com/company/edilbloc)